

ETL LISTED
277V MODELS

HH/PHH Series

Horizontal Fan Coil

Chilled Water - Hot Water / Electric Heat

300 - 1400 CFM, 2 - 12 KW



Description :

The **HH** series fan coil is a completely factory assembled chilled water fan coil with factory installed electric heat. It is designed for minimum installation cost and optimum serviceability. The space - saving **HH** is only 10" high (without R/A plenum) and is engineered to provide easy access for service and maintenance of the entire assembly. All standard models include 240V 2-speed motor, electric heat and controls, 24/240V relay / transformer, insulated drain pan, and copper tube coil. All models are dual rated for 208/240V.

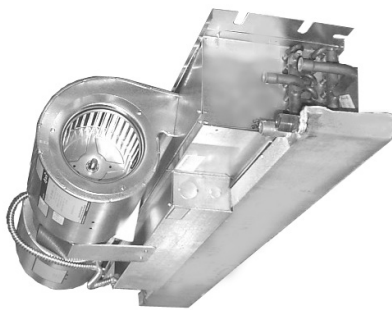

HH SERIES

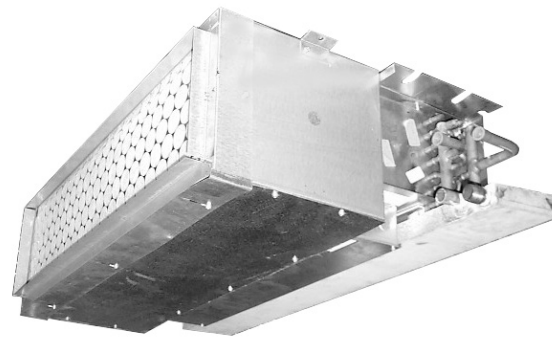

PHH SERIES
(with R/A Plenum)



FEATURES:

1. Factory installed **heating element(s)**
2. Insulated and **sloped drain pan**
3. **High efficiency** copper tube coil
4. 24/240V transformer for **low voltage control**
5. **Primary and secondary** condensate drains
6. **2 speed** motors (high speed for cooling, low speed for heating)
7. **Galvanized steel** construction
8. Manual **air vents**

OPTIONS: (contact factory)

1. 277V models are ETL Listed
2. Factory installed return air plenums with filters (insulated)
3. Factory or field installed motorized valve / hand valve clusters. (contact factory)
4. Aquastats, thermostats, rubber grommets, etc. (all field installed)
5. Drip pan extension for factory installed valve clusters (field installed)
6. Ceiling access / return air grilles

PHYSICAL DIMENSIONS (LESS PLENUM)					
MODEL	A	B	C	NUMBER OF MOTORS	NUMBER OF BLOWERS
3HHS	25	19-11/16	15	1	1
4HHS, 6HHS, 6HH, 8HH	40	34-11/16	30	1	2
10HH	46	40-11/16	36	1	2
12HH	52	46-11/16	42	1	2

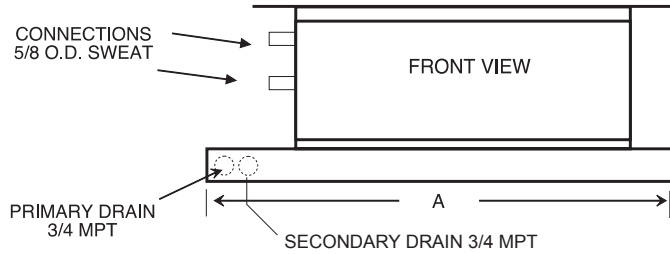
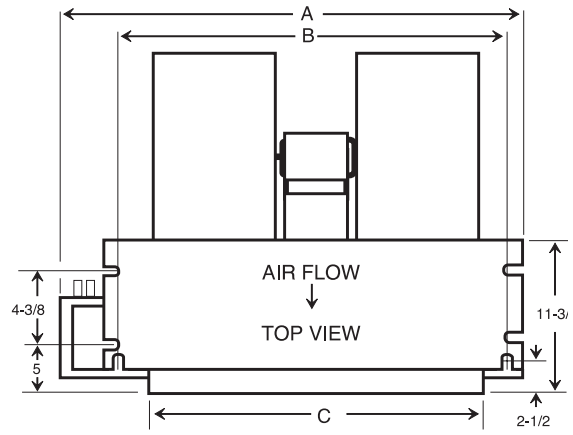
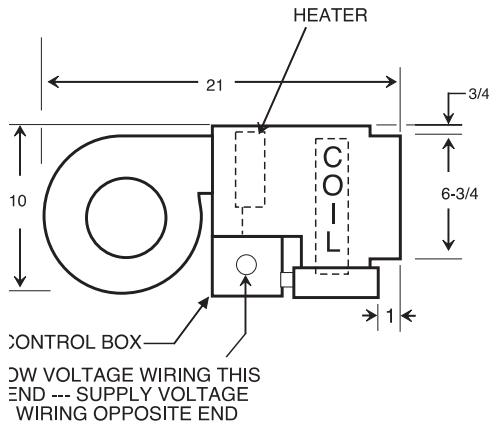

NOTE: RIGHT HAND MODEL SHOWN - LEFT HAND MODEL HAS DRAIN AND PIPING CONNECTIONS ON OPPOSITE SIDE OF FAN COIL.

In keeping with its policy of continuous progress and product improvement, First Operations reserves the right to make changes without notice. Maintenance for all First Co. products is available under "Product Maintenance" at www.firstco.com.



PLENUM DATA				
MODEL	A	B	C	D (FILTER)
3PHHS	20	18	15	10 X 20 X 1
4PHHS, 6PHHS, 6PHH, 8PHH	34	32	30	10 X 34 X 1
10PHH	40	38	36	10 X 40 X 1
12PHH	46	44	42	10 X 46 X 1

NOTE: 1. Return plenums are insulated
2. All plenums include throw away filter

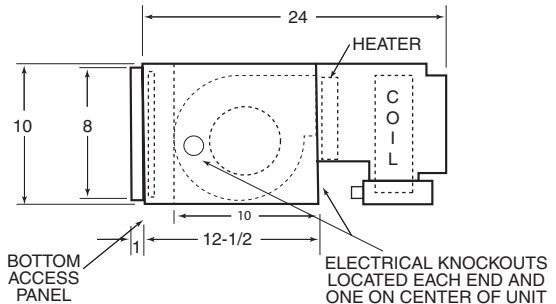
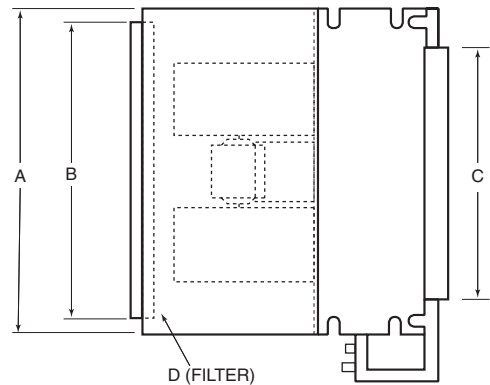

ELECTRICAL DATA (240V)									
UNIT MODEL	NOM. CFM	HEAT		TOTAL AMPS (2)	MIN. CIR. AMPACITY		(2) MAX FUSE		
		kW	BTUH		208V	230V	208V	230V	
3HHS	300	-2	2	6,820	9.3	11	12	15	15
		-3	3	10,230	13.5	15	17	15	20
		-4	4	13,640	17.6	20	23	20	25
		-5	5	17,050	21.8	24	28	25	30
4HHS	400	-3	3	10,230	13.3	15	17	15	20
		-5	5	17,050	21.6	24	27	25	30
		-6	6	20,460	25.8	28	33	30	35
6HHS	600	-3	3	10,230	14.1	16	18	20	20
		-5	5	17,050	22.4	23	28	25	30
		-6	6	20,460	26.6	30	34	30	35
		-8	8	27,280	34.9	39	44	40	45
6HH	600	-3	3	10,200	14.5	16	20	20	20
		-4	4	13,640	18.6	24	21	25	25
		-5	5	17,000	22.8	25	30	25	30
		-6	6	20,500	27.0	30	35	30	35
		-8	8	27,300	35.3	39	47	40	50
		-10	10	34,100	43.6	48	55	50	60
8HH	800	-3	3	10,200	14.5	16	20	20	20
		-4	4	13,640	18.6	24	21	25	25
		-5	5	17,000	22.8	25	30	25	30
		-6	6	20,500	27.0	29	35	30	35
		-8	8	27,300	35.3	39	47	40	50
		-10	10	34,100	43.6	48	55	50	60
10HH	1000	-3	3	10,200	14.5	16	20	20	20
		-4	4	13,640	18.6	24	21	25	25
		-5	5	17,000	22.8	25	30	25	30
		-6	6	20,500	27.0	29	35	30	35
		-8	8	27,300	35.3	39	47	40	50
		-10	10	34,100	43.6	48	55	50	60
12HH	1200	-3	3	10,200	15.3	18	20	20	20
		-5	5	17,000	23.6	27	30	30	30
		-6	6	20,500	27.8	31	35	35	35
		-8	8	27,300	36.1	40	46	40	50
		-10	10	34,100	44.5	49	56	50	60

- (1) Heating ratings at 240 volt, derate 25% for 208 volt application
(2) Includes motor and heaters (at 240V)

ELECTRICAL DATA (277V)								
UNIT MODEL	NOM. CFM	HEAT kW @ 277V	MOTOR HP	MOTOR AMPS	TOTAL AMPS @ 277V (1)	MIN. CIR. AMPACITY	(2) MAX FUSE	
						@ 277V	@ 277V	
3HHS	300	-1-277	1	1/20	.50	4.1	6	15
		-2-277	2			7.7	10	15
		-3-277	3			11.3	15	15
4HHS	400	-1-277	1	1/15	.52	4.1	6	15
		-2-277	2			7.7	10	15
		-3-277	3			11.4	15	15
		-4-277	4			15.0	19	20
6HHS	600	-1-277	1	1/15	.52	4.1	6	15
		-2-277	2			7.7	10	15
		-3-277	3			11.4	15	15
		-4-277	4			15.0	19	20
6HH	600	-1-277	1	1/12	.60	4.2	5	15
		-2-277	2			7.8	10	15
		-3-277	3			11.4	15	15
		-4-277	4			15.0	19	20
		-5-277	5			18.7	24	30
		-6-277	6			22.3	28	30
8HH	800	-1-277	1	1/6	.80	4.4	6	15
		-2-277	2			8.0	10	15
		-3-277	3			11.6	15	15
		-4-277	4			15.2	19	20
		-5-277	5			18.9	24	30
		-6-277	6			22.5	28	30
		-8-277	8			29.7	38	40
		10HH	1000			-2-277	2	1/4
-3-277	3			12.1	16	20		
-4-277	4			15.8	20	20		
-5-277	5			19.4	25	30		
-6-277	6			23.0	29	30		
-8-277	8			30.2	38	40		
-10-277	10			37.4	47	50		
12HH	1200	-2-277	2	1/3	2.0	9.2	12	15
		-3-277	3			12.8	16	20
		-4-277	4			16.5	21	25
		-5-277	5			20.0	25	30
		-6-277	6			23.7	30	30
		-10-277	10			38.1	48	50

- (1) Includes motor and heaters

In keeping with its policy of continuous progress and product improvement, First Co. reserves the right to make changes without notice. Maintenance for all First Co. products is available under "Product Maintenance" at www.firstco.com.

COOLING / HEATING CAPACITIES							
MODEL	COIL ROWS	NOM. CFM	GPM	P.D. (FT. WTR.)	TOTAL (2) COOLING	SENSIBLE COOLING	WATER (3) HEATING CAPACITY
3HHS	3	270	1.0	1.4	6.1	5.1	18.9
			2.0	5.0	8.1	5.9	21.0
			3.0	10.5	8.9	6.2	21.8
4HHS	4	215	1.0	1.8	6.7	5.1	18.8
			2.0	6.3	8.4	5.7	20.5
			3.0	13.1	9.0	6.0	21.1
4HHS	3	410	1.5	4.2	11.1	8.6	32.2
			2.0	7.0	12.5	9.2	33.6
			2.5	10.5	13.5	9.5	34.5
4HHS	4	390	1.5	5.8	12.5	9.3	34.9
			2.0	9.7	14.1	9.9	36.4
			2.5	14.5	15.1	10.3	37.4
6HHS	3	535	3.0	5.7	15.3	11.3	41.1
			4.0	9.5	16.6	11.8	42.4
			5.0	14.2	17.5	12.1	43.3
6HHS	4	490	3.0	3.9	16.5	11.9	43.5
			4.0	6.5	18.0	12.5	45.0
			5.0	9.7	18.9	12.8	46.0
6HH	3	600	3.0	5.7	16.3	12.3	44.2
			4.0	9.5	17.7	12.8	45.7
			5.0	14.2	18.7	13.1	46.7
6HH	4	600	3.0	3.9	18.2	13.7	50.1
			4.0	6.5	20.1	14.4	52.0
			5.0	9.7	21.3	14.8	53.2
8HH	3	800	4.0	5.4	19.6	15.0	54.2
			5.0	8.0	21.1	15.6	55.8
			6.0	11.0	22.1	15.9	56.9
8HH	4	800	4.0	6.5	23.2	17.4	63.4
			5.0	9.6	24.9	18.0	65.3
			6.0	13.3	26.2	18.5	66.5
10HH	3	1000	4.0	5.5	22.9	18.1	65.5
			5.0	8.4	24.9	18.8	67.7
			6.0	11.7	26.3	19.3	69.2
10HH	4	1000	4.0	4.3	28.6	21.5	78.3
			5.0	6.5	30.3	22.1	80.2
			6.0	9.1	31.6	22.6	81.6
12HH	3	1200	6.0	7.9	28.6	22.0	79.4
			7.0	10.5	30.0	22.5	81.0
			8.0	13.3	31.2	23.0	82.3
12HH	4	1200	6.0	10.0	33.9	25.6	93.2
			7.0	13.1	35.6	26.2	95.1
			8.0	16.5	37.0	26.8	96.6

(1) Cooling at 80DB/67WB, 45°F EWT.

(2) Heating at 70DB/180°F EWT.

AIR STANDARD APPROVED RATINGS								
MODEL	COIL	CFM	GPM	P.D. (FT. WTR.)	COOLING (1000 BTUH)		POWER INPUT (WATTS)	TYPE MOTOR
					TH	SH		
3HHS(*)-240-3	3 ROW	310	1.5	3.3	7.5	4.9	130	SP
4HHS(*)-240-3		410	2.6	12.0	12.9	8.9	90	SP
6HHS(*)-240-3		590	3.1	7.0	15.4	10.5	145	SP
6HH(*)-240-3		790	4.0	10.5	19.8	14.2	290	SP
8HH(*)-240-3		950	4.2	6.5	21.2	16.3	320	PSC
10HH(*)-240-3		1170	5.2	10.0	26.2	20.2	398	PSC
12HH(*)-240-3		1460	6.4	9.2	32.1	24.9	490	PSC
3HHS(*)-240-4	4 ROW	275	1.7	5.0	8.5	5.1	120	SP
4HHS(*)-240-4		400	3.2	24.0	15.8	9.8	88	SP
6HHS(*)-240-4		550	3.3	6.0	16.5	11.0	140	SP
6HH(*)-240-4		770	4.5	9.0	22.5	15.5	280	SP
8HH(*)-240-4		920	5.0	10.0	24.9	17.5	310	PSC
10HH(*)-240-4		1160	6.2	10.5	30.9	22.1	390	PSC
12HH(*)-240-4		1440	8.4	18.4	42.2	30.7	485	PSC

NOTE:

Ratings based on high fan speed, standard air at dry coil operation, 10 °F water temp. rise, ent. air 80DB, 67WB entering water at 45°F.

Rated in accordance with ARI Standard 440.

SH - sensible heat

TH - total heat

SP - shaded pole

PSC - perm. split capacitor

Power input is for motor only

BLOWER PERFORMANCE

HH - 240 Volt (3 - ROW COIL)

HH SERIES		CFM vs EXTERNAL STATIC PRESSURE (3 ROW)								
MODEL	H.P.	FAN SPEED	EXTERNAL STATIC PRESSURE (inches of water)							
			0.0	0.05	0.10	0.15	0.20	0.25	0.30	0.35
3HHS-3	1/30	COOL	300	270	235	205	---	---	---	---
		HEAT	265	240	210	200	---	---	---	---
4HHS-3	1/15	COOL	425	410	380	330	---	---	---	---
		HEAT	395	360	320	285	---	---	---	---
6HHS-3	1/12	COOL	605	535	485	425	---	---	---	---
		HEAT	500	390	320	270	---	---	---	---
6HH-3	1/8	COOL	---	---	805	770	735	700	665	625
		HEAT	---	---	700	970	640	610	580	550
8HH-3	1/4	COOL	---	---	895	860	825	795	760	725
		HEAT	---	---	775	750	720	690	655	625
10HH-3	1/4	COOL	---	---	1110	1075	1040	1000	955	915
		HEAT	---	---	715	695	670	645	620	600
12HH-3	1/3	COOL	---	---	1395	1345	1295	1245	1195	1145
		HEAT	---	---	950	920	890	855	820	775

HH - 240 Volt (4 - ROW COIL)

HH SERIES		CFM vs EXTERNAL STATIC PRESSURE (4 ROW)								
MODEL	H.P.	FAN SPEED	EXTERNAL STATIC PRESSURE (inches of water)							
			0.0	0.05	0.10	0.15	0.20	0.25	0.30	0.35
3HHS-4	1/30	COOL	255	215	200	175	---	---	---	---
		HEAT	230	200	175	150	---	---	---	---
4HHS-4	1/15	COOL	410	390	335	265	---	---	---	---
		HEAT	325	320	290	235	---	---	---	---
6HHS-4	1/12	COOL	535	490	435	365	---	---	---	---
		HEAT	350	335	320	290	---	---	---	---
6HH-4	1/8	COOL	---	---	740	705	675	640	605	565
		HEAT	---	---	650	625	600	570	535	495
8HH-4	1/4	COOL	---	---	810	780	750	715	680	645
		HEAT	---	---	730	700	670	640	610	580
10HH-4	1/4	COOL	---	---	1070	1030	995	960	930	895
		HEAT	---	---	775	750	725	700	670	640
12HH-4	1/3	COOL	---	---	1270	1215	1165	1115	1070	1025
		HEAT	---	---	950	915	880	850	820	790

BLOWER PERFORMANCE

PHH - 240 Volt (3 - ROW COIL)

PHH SERIES	CFM vs EXTERNAL STATIC PRESSURE (3 ROW)									
MODEL	H.P.	FAN SPEED	EXTERNAL STATIC PRESSURE (inches of water)							
			0.0	0.05	0.10	0.15	0.20	0.25	0.30	0.35
3PHHS-3	1/30	COOL	270	255	215	180	---	---	---	---
		HEAT	250	215	185	160	---	---	---	---
4PHHS-3	1/15	COOL	430	395	350	295	---	---	---	---
		HEAT	340	320	295	255	---	---	---	---
6PHHS-3	1/12	COOL	570	490	415	335	---	---	---	---
		HEAT	290	285	270	240	---	---	---	---
6PHH-3	1/8	COOL	---	---	710	660	615	570	530	485
		HEAT	---	---	625	575	535	495	460	415
8PHH-3	1/4	COOL	---	---	860	830	800	770	740	710
		HEAT	---	---	555	540	525	505	490	470
10PHH-3	1/4	COOL	---	---	1050	1010	965	920	875	825
		HEAT	---	---	760	735	710	675	640	600
12PHH-3	1/3	COOL	---	---	1240	1205	1165	1115	1065	1005
		HEAT	---	---	910	870	835	805	765	720

PHH - 240 Volt (4 - ROW COIL)

PHH SERIES	CFM vs EXTERNAL STATIC PRESSURE (4 ROW)									
MODEL	H.P.	FAN SPEED	EXTERNAL STATIC PRESSURE (inches of water)							
			0.0	0.05	0.10	0.15	0.20	0.25	0.30	0.35
3PHHS-4	1/30	COOL	225	195	165	---	---	---	---	---
		HEAT	210	175	145	---	---	---	---	---
4PHHS-4	1/15	COOL	420	375	315	---	---	---	---	---
		HEAT	330	305	265	---	---	---	---	---
6PHHS-4	1/12	COOL	500	450	395	---	---	---	---	---
		HEAT	325	320	300	---	---	---	---	---
6PHH-4	1/8	COOL	---	---	680	645	610	570	530	490
		HEAT	---	---	645	565	485	430	395	360
8PHH-4	1/4	COOL	---	---	740	690	645	605	560	515
		HEAT	---	---	650	610	570	530	490	445
10PHH-4	1/4	COOL	---	---	990	950	915	875	840	800
		HEAT	---	---	750	725	700	675	650	620
12PHH-4	1/3	COOL	---	---	1200	1150	1110	1065	1020	975
		HEAT	---	---	900	870	840	800	760	710

BLOWER PERFORMANCE

HH - 277 Volt (3 - ROW COIL)

HH SERIES	CFM vs EXTERNAL STATIC PRESSURE (3 ROW)									
MODEL	H.P.	FAN SPEED	EXTERNAL STATIC PRESSURE (inches of water)							
			0.0	0.05	0.10	0.15	0.20	0.25	0.30	0.35
3HHS-3	1/20	COOL	295	260	230	195	---	---	---	---
		HEAT	250	215	185	150	---	---	---	---
4HHS-3	1/15	COOL	460	420	375	320	---	---	---	---
		HEAT	400	365	325	260	---	---	---	---
6HHS-3	1/15	COOL	550	480	415	345	---	---	---	---
		HEAT	445	395	335	265	---	---	---	---
6HH-3	1/12	COOL	---	---	630	600	570	540	510	---
		HEAT	---	---	525	495	465	440	---	---
8HH-3	1/6	COOL	---	---	795	760	730	695	660	620
		HEAT	---	---	705	675	645	615	580	540
10HH-3	1/4	COOL	---	---	1045	1005	960	920	880	840
		HEAT	---	---	875	830	790	750	710	670
12HH-3	1/3	COOL	---	---	1410	1370	1330	1290	1245	1195
		HEAT	---	---	1230	1200	1165	1130	1090	1040

HH - 277 Volt (4 - ROW COIL)

HH SERIES	CFM vs EXTERNAL STATIC PRESSURE (4 ROW)									
MODEL	H.P.	FAN SPEED	EXTERNAL STATIC PRESSURE (inches of water)							
			0.0	0.05	0.10	0.15	0.20	0.25	0.30	0.35
3HHS-4	1/20	COOL	260	230	200	175	---	---	---	---
		HEAT	225	195	170	145	---	---	---	---
4HHS-4	1/15	COOL	435	380	325	255	---	---	---	---
		HEAT	385	335	290	225	---	---	---	---
6HHS-4	1/15	COOL	510	430	365	290	---	---	---	---
		HEAT	440	380	310	215	---	---	---	---
6HH-4	1/128	COOL	---	---	600	570	540	510	470	435
		HEAT	---	---	505	475	450	420	385	350
8HH-4	1/6	COOL	---	---	755	720	685	650	615	570
		HEAT	---	---	665	635	605	570	535	500
10HH-4	1/4	COOL	---	---	985	975	910	875	845	810
		HEAT	---	---	860	820	785	750	720	685
12HH-4	1/3	COOL	---	---	1300	1255	1210	1165	1125	1075
		HEAT	---	---	1160	1120	1085	1045	1005	960

BLOWER PERFORMANCE

PHH - 277 Volt (3 - ROW COIL)

PHH SERIES	CFM vs EXTERNAL STATIC PRESSURE (3 ROW)									
MODEL	H.P.	FAN SPEED	EXTERNAL STATIC PRESSURE (inches of water)							
			0.0	0.05	0.10	0.15	0.20	0.25	0.30	0.35
3PHHS-3	1/20	COOL	265	235	205	170	---	---	---	---
		HEAT	230	195	165	135	---	---	---	---
4PHHS-3	1/15	COOL	440	390	340	270	---	---	---	---
		HEAT	380	345	310	240	---	---	---	---
6PHHS-3	1/15	COOL	525	445	375	300	---	---	---	---
		HEAT	425	370	305	225	---	---	---	---
6PHH-3	1/12	COOL	---	---	565	515	470	420	375	---
		HEAT	---	---	445	400	360	---	---	---
8PHH-3	1/6	COOL	---	---	745	715	690	665	650	635
		HEAT	---	---	660	630	600	570	535	495
10PHH-3	1/4	COOL	---	---	990	950	910	870	830	795
		HEAT	---	---	870	830	795	765	730	700
12PHH-3	1/3	COOL	---	---	1305	1260	1220	1185	1145	1100
		HEAT	---	---	1180	1140	1105	1070	1030	990

PHH - 277 Volt (4 - ROW COIL)

PHH SERIES	CFM vs EXTERNAL STATIC PRESSURE (3 ROW)									
MODEL	H.P.	FAN SPEED	EXTERNAL STATIC PRESSURE (inches of water)							
			0.0	0.05	0.10	0.15	0.20	0.25	0.30	0.35
3PHHS-4	1/20	COOL	240	215	180	160	---	---	---	---
		HEAT	205	180	150	125	---	---	---	---
4PHHS-4	1/15	COOL	415	360	305	235	---	---	---	---
		HEAT	375	320	265	200	---	---	---	---
6PHHS-4	1/15	COOL	485	410	330	250	---	---	---	---
		HEAT	420	345	280	210	---	---	---	---
6PHH-4	1/12	COOL	---	---	560	525	490	455	415	370
		HEAT	---	---	480	445	415	380	350	---
8PHH-4	1/6	COOL	---	---	660	610	565	520	470	415
		HEAT	---	---	585	535	490	445	395	350
10PHH-4	1/4	COOL	---	---	925	890	860	830	795	765
		HEAT	---	---	820	790	765	740	710	680
12PHH-4	1/3	COOL	---	---	1190	1145	1106	1065	1030	995
		HEAT	---	---	1070	1030	995	960	920	885

“Twilight Electric” Fan Coil Installations (Supplemental Seasonal Electric Heat)

Developers in many parts of the country are giving a great deal of attention to the “twilight electric” fan coil system for heating and cooling. The interest in this system is a result of being able to offer individual unit control which provides the room comfort of a four-pipe fan coil system yet maintains most of the economic advantages of a two-pipe installation. Often mortgage money has a restriction of individual unit control as a condition of the mortgage and the twilight electric system provides one way to satisfy this requirement without greatly increasing either installation or operating costs as compared to the familiar two-pipe system.

The twilight electric system is a two-pipe fan coil unit with a small kilowatt electric resistance heater element added. When properly furnished with adequate controls, the electric heating element provides limited heating capability for use in mild weather during seasonal changeover of the central-chiller-boiler system. During the winter season, with the central boiler operational, the system functions as a standard two-pipe system utilizing hot water as the heating source. Because the electric heat is only intended to provide a limited amount of heat during mild weather, the size of the heater is relatively small, usually selected to provide adequate heat with about a 50 degree outdoor temperature.

The operational advantage of a twilight system is obvious when the requirements of the heating-cooling system during the Spring and Fall seasons are considered. During the morning hours heating may be required in some or all of the separate units while the afternoon hours may require cooling. Once again the evening hours may again require heating. The normal two-pipe system simply cannot cope with rapid changes in demand from heating to cooling. With the addition of electric heat, the central system is simply operated in its cooling mode and all demands for heat are satisfied with the electric heaters. Should an extended period of cold weather develop, the central system is then changed over to its heating mode and hot water is again used to provide the necessary heat. This changeover can be achieved with automatic controls on the central equipment.

The included diagram illustrates the typical control arrangement. Both aquastats are strapped to the water supply piping and the 3-way motorized valve is also located in the supply line.

The system functions as follows:

I. Central system in cooling mode. Chilled water available to the fan coil units.

A. Thermostat calls for cooling - The (Y) terminal at the thermostat is energized and voltage is applied to the motorized valve by aquastat No. 2 which is in the cold position. The valve opens and allows a flow of water through the unit coil. At the same time the (G) terminal at the thermostat is energized which causes the fan relay to start the fan motor. When the thermostat is satisfied both the fan motor and motorized valve cycle off.

B. Thermostat calls for heating - The (W) terminal of the thermostat is energized and voltage is applied to aquastat No. 1. Since the aquastat senses the cold water, its contact is closed in the cold position and voltage is fed to the (W) connection at the control box which causes the electric heat contactor to close energizing the electric heaters. At this time the (G) connection is also energized bringing the fan on. The factory wired box is wired to provide fan operation any time the electric heaters are energized. This interlock is necessary during the cycling operation of the silent contactors.

II. Central system in heating mode. Hot water available to the fan coil units.

A. Thermostat calls for heat - The (W) terminal at the thermostat is energized and voltage is applied to aquastat No. 1. Since the aquastat senses the hot water, its contact is closed to the hot position and voltage is fed to the motorized valve which opens and allows a flow of water through the unit coil. At the same time the (G) terminal of the thermostat is energized which causes the fan relay to start the fan motor. When the thermostat is satisfied both the fan motor and motorized valve cycle off.

B. Thermostat calls for cooling - Should the thermostat call for cooling while hot water is in the system the (Y) terminal of the thermostat is energized but aquastat No. 2 is in the hot position and no power can get through to the motorized valve. Since the (G) terminal at the thermostat is also energized the fan motor will run but this is the only response.

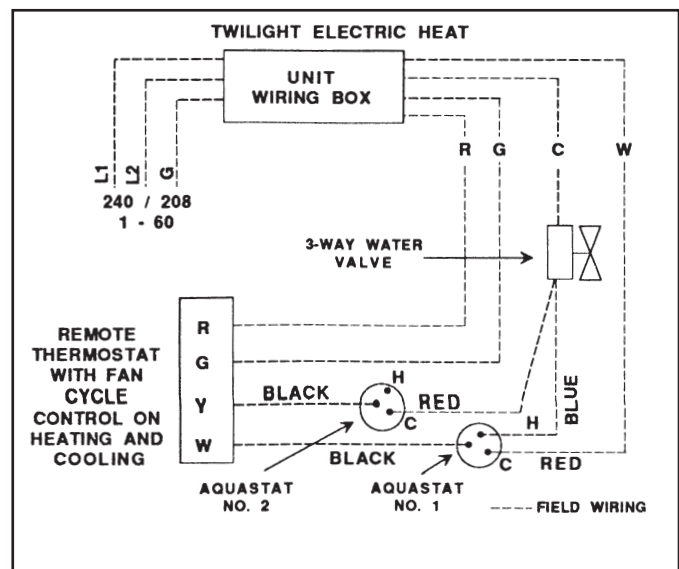
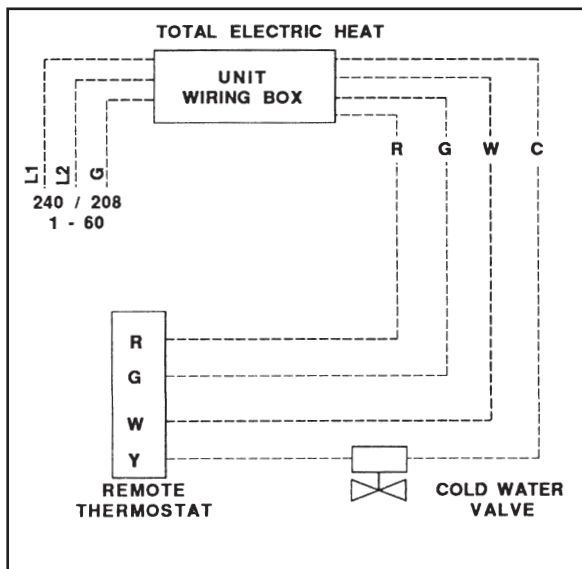

VALVE CLUSTERS AND INDIVIDUAL COMPONENTS: (field installed (1))			
Assembled Valve Clusters: (factory-assembled and field installed) Components are factory piped together (order power heads separately). Contact factory for other valve clusters			
	Right Hand	Left Hand	Description (all 1/2") - For all HH / PHH
2 pipe	9VHR2BV	9VHL2BV	2-pipe, 2 hand valves only
	9VHR22B	9VHL22B	2-pipe, one 2-way valve body and 2 hand valves
	9VHR23B	9VHL23B	2-pipe, one 3-way valve body and 2 hand valves
4 pipe	9VHR4BV	9VHL4BV	4-pipe, 2 hand valves only
	9VHR42B	9VHL42B	4-pipe, one 2-way valve body and 2 hand valves
	9VHR43B	9VHL43B	4-pipe, one 3-way valve body and 2 hand valves
Power Heads: (two power heads required for 4-pipe) - For all units			
E50131180		24V	
E50132180		110V/50Hz - 120V/60Hz	
E50137180		277V	
E50138180		220V/50Hz - 230V/60Hz	
Separate Valve Bodies: (order power heads separately)			
E421213		1/2" 2-way - For HH/PHH	
E431213		1/2" 3-way - For HH/PHH	
Hand Valves: (Combination balance / shut-off) (2 usually required per coil)			
CP9		1/2"	
Circuit Setters and Strainers			
CP601		1/2" Circuit Setter (Taco)	
CP603		1/2" Strainer (Kitz)	

(1) Contact factory for information concerning factory mounting.

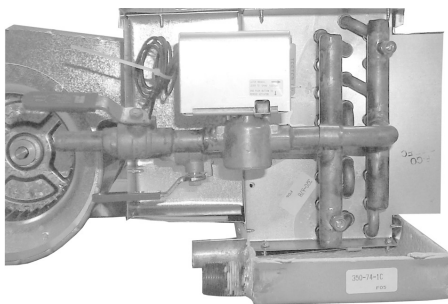

MOUNTED 2 WAY VALVE CLUSTER (RIGHT HAND SHOWN)

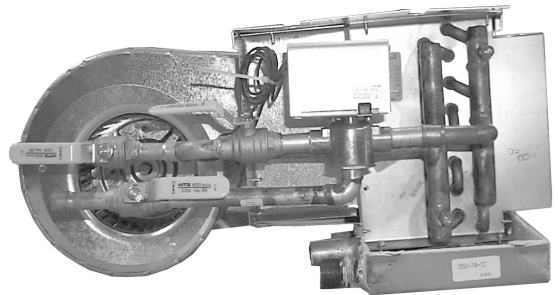

MOUNTED 3 WAY VALVE CLUSTER (RIGHT HAND SHOWN)

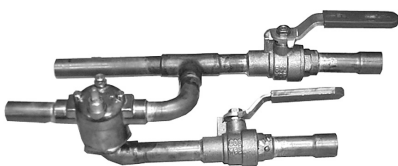

Assembled Valve Cluster (3-way)

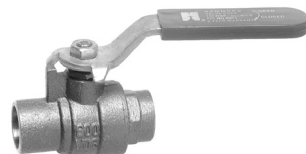

CP9

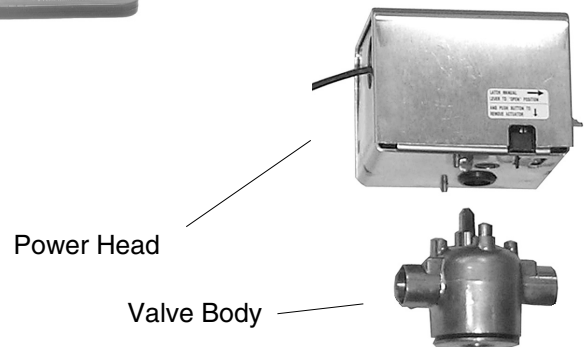

Power Head

Valve Body

Guide Specifications

Furnish and install fan coil units as indicated on the plans.

Units shall be certified to deliver published capacities when tested in accordance with latest ARI Standard 440.

Units shall be complete with water coil, one or more centrifugal fans, condensate drain pan, electric heat with controls, and galvanized steel casing.

Coils shall be (3-row) (4-row) (4-row split) (5-row split) with staggered 3/8 in. O.D. copper tubes mechanically bonded to aluminum fins with 5/8 in. O.D. copper tube connections. All coils shall be factory leak tested at 400 psig minimum air pressure. Coils shall have manual air vents.

Motors shall be 2 or 3-speed permanent split capacitor type with built-in overload protection and sleeve bearings with oil tubes. Voltage is 230V/60Hz.

Drain pan shall be insulated with expanding foam, fire retardant insulation to prevent sweating. Primary drain connection shall be 3/4 in. MPT. Pan shall be furnished with 3/4 in. MPT secondary overflow drain connection. All drain pans are sloped toward the drain connections to facilitate condensate removal.

Exposed units and panels shall have a baked on off-white finish.

Thermostats and Accessories (all field installed)

PART NO	VOLTS	DESCRIPTION	MANUFACTURER
T334	24	SINGLE SPEED WALL STAT	---
T4071	120/24	AQUASTAT	---
919-1	---	EXTENDED DRIP LIP	---
CP34	---	RUBBER GROMMETS	---



Ceiling Access Panels

PART NO	FRAME DIMENSIONS	TYPE	FOR FIRST CO. FAN COIL MODELS
965 965-1	27-1/2 X 43	LOUVERED SOLID	3-8HH/PHH
966 966-1	27-1/2 X 49	LOUVERED SOLID	10HH/PHH
967 967-1	27-1/2 X 55-1/2	LOUVERED SOLID	12HH/PHH



965-1
(Solid panel shown)

- NOTES:**
1. Panels are surface mount and coated with white baked on epoxy paint.
 2. Filter clips are provided on louvered models (no filter).
 3. Panel doors are hinged and include special "Captive" type screws.



