



WSV6

Vertical Water Source Heat Pump



3/4 thru 6 Tons

3/4 thru 10 Tons

R454B



NOMENCLATURE

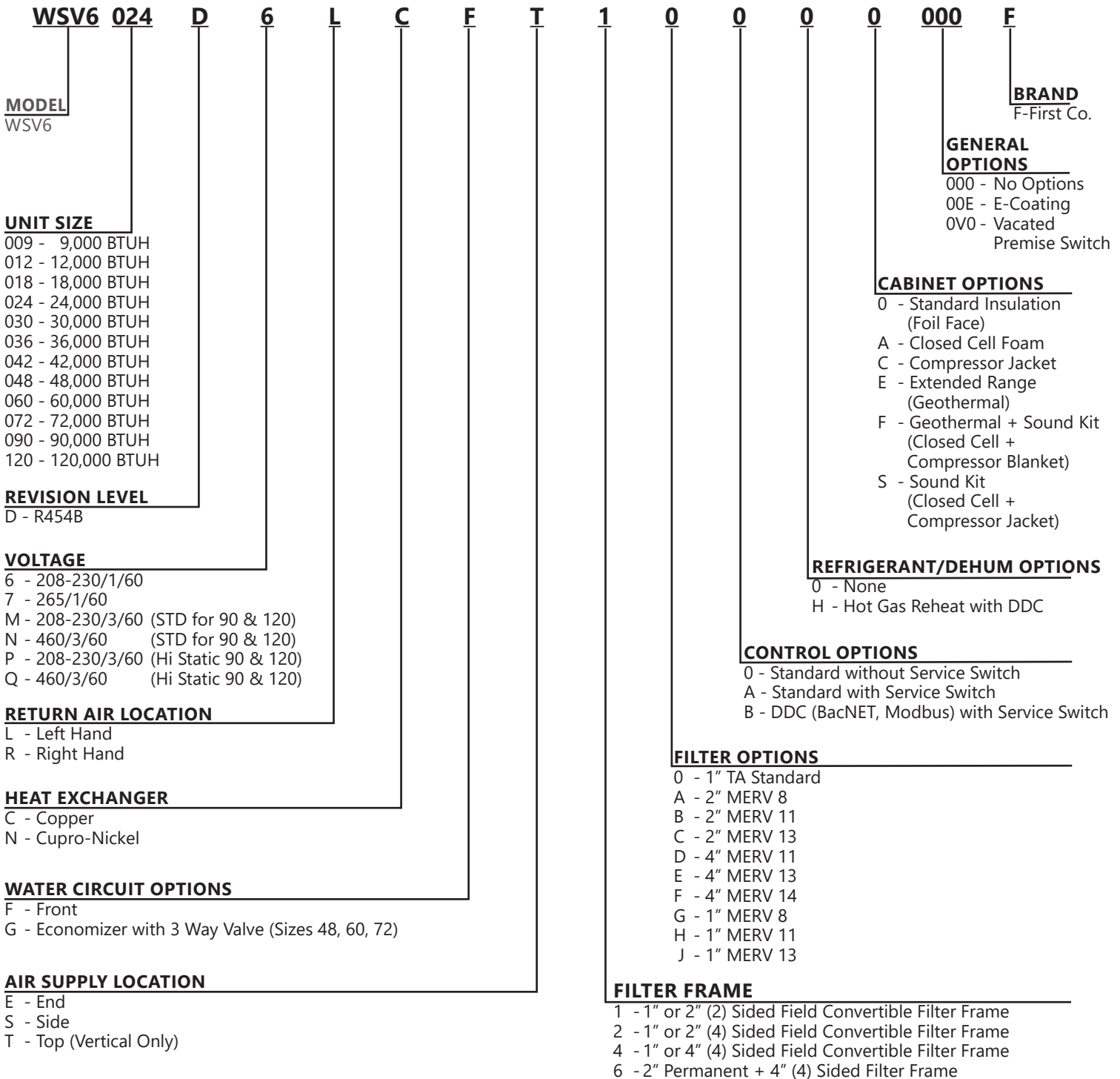

WSV6

VERTICAL WATER SOURCE HEAT PUMP

STANDARD FEATURES

The HydroTech includes many standard features found only in higher priced products, plus a number of unique features including:

- **Optional Vacated Premises Control (VPC) Kit with reset feature:** Ensures that the unit will operate a minimum of one or two hours per day during extended periods of unoccupancy. This option also includes an automatic reset feature. If a fault occurs, the system will shut down, but then automatically reset every 24 hours. If the same fault exists each day, the unit will lockout on the fourth day and have to be manually reset.
- **Superior insulation:** Air handling section lined with 1" fiberglass insulation with FSK which is a flame retardant, vapor barrier. Condensing section lined with 1" fiberglass insulation on access panels, mid panel. Improves quality, efficiency, and control condensation.
- **Removable discharge flange:** Provides additional installation clearance.
- **Filter rack:** Standard Filter rack can hold 1" or 2" filters. Optional 4" filter rack available with 2" or 4" filters. Optional 6" filter rack available with 2" and 4" filters.
- **Tool-less filter rack installation:** Can be installed after the unit is in the closet, providing additional installation clearance.
- **State-of-the-art Digital Control Module**

ADDITIONAL STANDARD FEATURES

- 100% factory tested!
- All units operate with environmentally friendly R-454B refrigerant.
- Stainless steel condensate pan-sloped for positive drainage (WSV6090 model).
- Non-corrosive thermoplastic condensate pan-sloped for positive drainage (WSV672 model).
- High and low pressure service ports
- Refrigerant filter-drier
- Panel-mounted FPT water connections
- No back-up wrench needed.
- Removable panels for service
- 75 VA transformer (WSV6090 model)/50 VA transformer (WSV672 model)
- 1"-2" field convertible filter rack with 1" throwaway filter
- Disconnect switch and phase monitor
- Water coil freeze sensor
- Air coil freeze sensor
- Condensate overflow sensor



WSV6

VERTICAL WATER SOURCE HEAT PUMP

OPTIONAL FEATURES

- Cupronickel coaxial heat exchanger
- Vacated Premises Control
- E-Coated air coil corrosion protection
- Evaporator temperature sensor
- **WSV672 Optional Features:**
 - Compressor Cover: A heavy duty, insulated compressor cover that reduces unwanted compressor noise.
 - Extended range (geothermal)
 - Hot gas reheat
 - Waterside Economizer (sizes 48, 60 and 72 only)

DEFINITIONS

ABBREVIATIONS AND DEFINITIONS

CFM	=	airflow, cubic feet per minute
EWT	=	entering water temperature, °F
GPM	=	water flow in gallons per minute
WPD	=	water pressure drop, psi and feet of water
EAT	=	entering air temperature, °F (dry bulb/wet bulb)
HC	=	air heating capacity, MBtu/h
TC	=	total cooling capacity, MBtu/h
HR	=	total heat of rejection, MBtu/h
HE	=	total heat of extraction, MBtu/h
HGRH	=	hot gas reheat
EER	=	Energy Efficient Ratio
COP	=	Coefficient of Performance
LWT	=	leaving water temperature, °F
LAT	=	leaving air temperature, °F
TH	=	total heating capacity, MBtu/h
LC	=	latent cooling capacity, MBtu/h
S/T	=	sensible to total cooling ratio

WSV6

VERTICAL WATER SOURCE HEAT PUMP

DIGITAL CONTROL MODULE

Controls unit operation and monitors all safety controls. (Patent Pending)

STANDARD FEATURES

- Digital Diagnostic Display - A two-digit display indicates the current operational mode or a fault code
- 24V Status LED - Green light indicates 24V power to the control module
- VPC (Vacated Premises Control) - Allows the unit to operate for either 1 or 2 hours per day (total) during extended periods of unoccupancy (requires optional kit).
- Nuisance Trip Protection - Unit will attempt to start up to three times with a fault signal. If the fault continues, the unit locks out.
- Condensate overflow lockout
- High and low pressure controls
- Water Coil low temperature protection
- Over / Under voltage protection
- Random re-start timer
- Anti-short cycle timer
- Test Mode With LED indicator - speeds up control timers for service personnel
- Alarm Relay - Activated if the unit locks out
- Conformal coating (both sides) for humidity and condensation protection

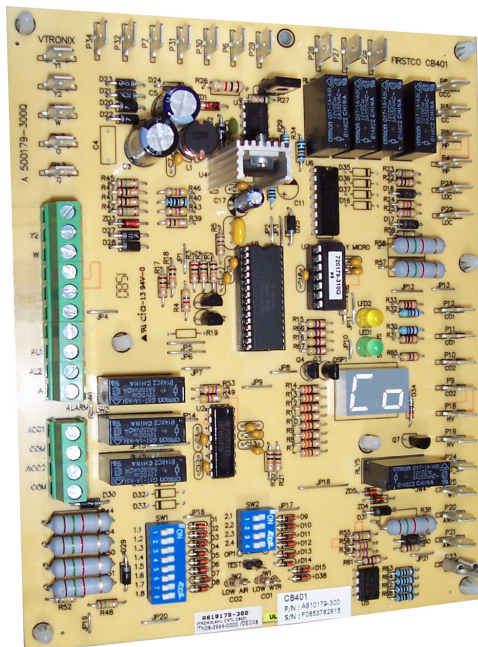

Electronic Control Module



Thermoplastic Drain Pan
(WSV672 Model)

WSV6

VERTICAL WATER SOURCE HEAT PUMP

DIP SWITCHES

(FIELD SELECTABLE SETTINGS):

- 5 Second Compressor Delay - Blower starts before the compressor, which helps attenuate compressor start up sound.
- 45 Second Blower-off Delay - Increases cooling efficiency.
- Dehumidification Mode - Selects continuous low speed fan operation for increased humidity removal.
- VPC Switch - Selects one or two hour daily operation (requires optional kit)
- Lower Water and Air Coil Temperature Cutout Options - Optional 10°F. Cutouts for applications where water temperature is below 50°F. (Requires antifreeze solution).
- Two Accessory Relays - The relays can cycle with either the fan or compressor. In addition, relay number one can be configured for use with slow opening water valves (60 second pre-compressor initialization) and relay number 2 can be configured for a 30 second post fan delay.



DESCRIPTION OF OPERATION	LED Readout
NORMAL MODE	ON (Green Light)
CONTROLLER NON-FUNCTIONAL	OFF (Green Light)
TEST MODE (pins shorted momentarily)	ON (Yellow Light)
STANDBY	St
FAN ONLY (G active)	Fo
COOL (Y1 & O active)	Co
HEAT 1st Stage (Y1 active)	H1
ACCESSORY RELAY 1	A1
ACCESSORY RELAY 2	A2
VACATED PREMISES CONTROL	Ay
FAULTY RETRY	rE & CODE #
LOCKOUT	Lo & Code #
OVER / UNDER VOLTAGE SHUTDOWN	Ou & Code #
TEMPERATURE SENSOR ERROR	SE & CODE #
TEST MODE - NO FAULT	CODE 11
TEST MODE - HP FAULT	CODE 12
TEST MODE - LP FAULT	CODE 13
TEST MODE - CO1 FAULT	CODE 14
TEST MODE - CO2 FAULT	CODE 15
TEST MODE - COND. OVERFLOW FAULT	CODE 16
TEST MODE - OVER/UNDER SHUTDOWN	CODE 17
TEST MODE - SWAPPED CO1/CO2 THERMISTORS	CODE 18
TEST MODE - TEMPERATURE SENSOR ERROR	CODE 19

LBL02

Sight Glass on Door



Optional
Vacated Premises Selector Switch
(Kit# 9WS01)

WSV6

VERTICAL WATER SOURCE HEAT PUMP

3/4 TO 6 TON UNIT

DATA TABLES

DIMENSIONS

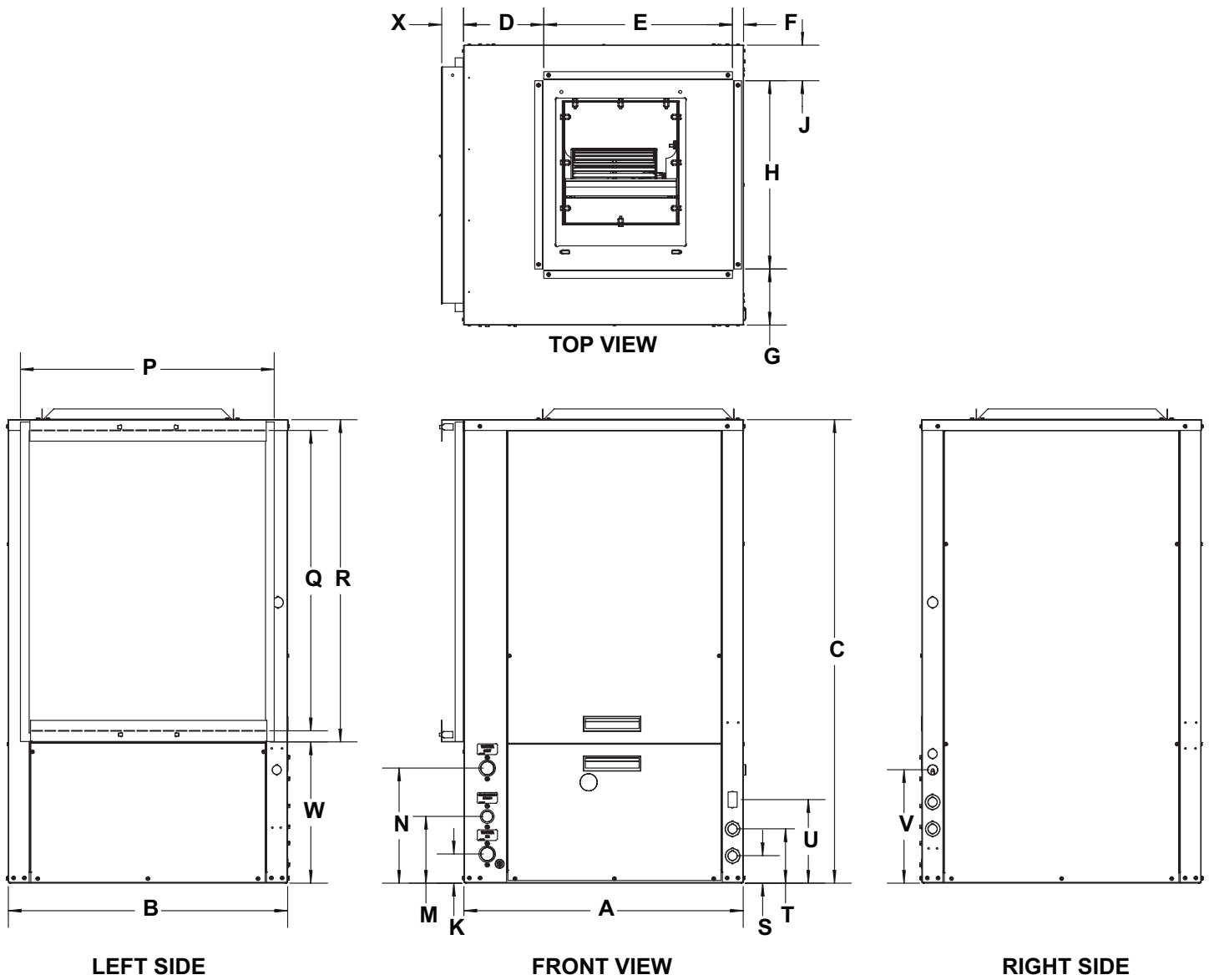

DIMENSIONS (CONT'D)

Dimensions Reference/Description	MODEL NUMBER										
	WSV6009	WSV6012	WSV6018	WSV6024	WSV6030	WSV6036	WSV6042	WSV6048	WSV6060	WSV6072	
A Width	21.50	21.50	21.50	21.50	21.50	21.50	26.00	26.00	26.00	26.00	
B Depth	21.50	21.50	21.50	21.50	21.50	26.00	26.00	26.00	26.00	26.00	
C Height	36.25	36.25	36.25	36.25	39.25	43.25	43.25	43.25	51.25	51.25	
D	9.50	9.50	5.50	5.50	5.50	5.00	7.25	7.25	5.20	5.20	
E Duct	7.75	7.75	13.75	13.75	13.75	15.75	17.75	17.75	19.00	19.00	
F	4.25	4.25	2.25	2.25	2.25	.75	1.00	1.00	1.75	1.75	
G	4.50	4.50	3.63	3.63	3.63	5.00	5.00	5.00	4.75	4.75	
H Duct	12.75	12.75	16.25	16.25	16.25	16.25	17.75	17.75	19.00	19.00	
J	4.25	4.25	1.75	1.75	1.75	4.75	3.25	3.25	3.35	3.35	
K Water In	2.75	2.75	2.75	2.75	2.75	2.75	2.75	2.75	2.75	2.75	
M Condensate Drain	7.25	7.25	7.25	7.25	7.25	7.25	6.25	6.25	6.25	6.25	
N Water Out	13.25	13.25	13.25	12.75	12.75	12.75	10.75 LH 16.75 RH	10.75	10.75	10.75	
P R/A Duct Flange Width	17.50	17.50	17.50	17.50	17.50	22.00	22.00	22.00	22.00	22.00	
Q R/A Duct Flange Height	16.00	16.00	16.00	16.00	18.00	22.00	28.00	28.00	36.00	36.00	
R Filter Rack Height	18.00	18.00	18.00	18.00	20.00	24.00	30.00	30.00	38.00	38.00	
S	4.25	4.25	4.25	4.25	4.25	4.25	2.50	2.50	2.50	2.50	
T	67.5	67.5	67.5	67.5	67.5	67.5	5.00	5.00	5.00	5.00	
U	10.50	10.50	10.50	10.50	10.50	10.50	7.75	7.75	7.75	7.75	
V	15.00	15.00	15.00	15.00	15.00	15.00	10.50	10.50	10.50	10.50	
W	18.25	18.25	18.25	18.25	19.00	19.00	13.25	13.25	13.25	13.25	
X	2.00	2.00	2.00	2.00	2.00	2.00	2.00	2.00	2.00	2.00	

NOTE:

1. Right Hand and Left Hand return air is determined by facing the front of the unit.

WSV6

VERTICAL WATER SOURCE HEAT PUMP

3/4 TO 6 TON UNIT

DATA TABLES

PERFORMANCE DATA

MODEL NUMBER	NOM. CFM	GPM	WATER LOOP (Entering Water Temperature)			
			86° Deg. F		68° Deg. F	
			COOLING	EER	HEATING	COP
WSV6009	340	2.3	9,200	16.0	10,000	4.8
WSV6012	440	3.0	11,500	16.0	13,200	4.7
WSV6018	625	4.5	17,800	16.0	19,500	4.6
WSV6024	800	6.0	22,600	16.0	26,000	4.9
WSV6030	925	7.5	28,000	16.0	31,000	4.7
WSV6036	1150	9.0	35,000	16.0	41,000	4.9
WSV6042	1330	10.5	42,000	15.6	45,000	4.9
WSV6048	1500	12.0	48,000	16.0	48,000	4.7
WSV6060	1875	15.0	60,000	16.0	67,000	4.8
WSV6072	1900	18.0	70,000	15.6	75,000	4.5

MODEL NUMBER	NOM. CFM	GPM	GROUND WATER (Entering Water Temperature)				GROUND LOOP (Entering Water Temperature)			
			59° Deg. F		50° Deg. F		77° Deg. F		32° Deg. F	
			COOLING	EER	HEATING	COP	COOLING	EER	HEATING	COP
WSV6009	340	2.3	11,000	26.0	8,800	4.3	9,800	19.0	6,800	3.7
WSV6012	440	3.0	13,500	26.0	11,000	4.1	12,500	19.0	9,000	3.6
WSV6018	625	4.5	20,000	21.1	16,000	4.1	18,000	17.2	13,000	3.6
WSV6024	800	6.0	24,000	23.0	22,000	4.1	23,000	18.0	17,500	3.6
WSV6030	925	7.5	30,000	22.5	24,000	4.1	28,000	17.5	19,900	3.6
WSV6036	1150	9.0	39,000	22.0	35,000	4.1	37,000	18.0	28,000	3.6
WSV6042	1330	10.5	44,000	24.0	37,000	4.3	42,000	18.0	30,000	3.6
WSV6048	1500	12.0	55,000	23.0	38,000	4.1	50,000	18.0	31,000	3.5
WSV6060	1875	15.0	67,000	23.8	53,500	4.3	63,000	18.0	42,500	3.6
WSV6072	1900	18.0	77,000	22.1	63,500	4.1	73,000	17.9	52,000	3.6

Cooling capacities based on 80.6°F DB, 66.2°F WB entering air temperature

Heating capacities based on 68°F DB, 59°F WB entering air temperature

All ratings based upon operation at lower voltage of dual voltage rated models

NOTE:

Ground loop requires extended range temperature package.

Data is subject to change. Please verify current information on www.firstco.com.

WSV6

VERTICAL WATER SOURCE HEAT PUMP

3/4 TO 6 TON UNIT

DATA TABLES

ELECTRICAL DATA

Model	Voltage	Compressor		Blower		MIN. CIRCUIT AMPACITY	MAX. CIRCUIT PROTECTION
		RLA	LRA	FLA	HP		
WSV6009*	208/230V-1-60	3.97	22	2.3	1/4	8	15
	265V-1-60	3.97	23	2.3	1/4	8	15
WSV6012*	208/230V-1-60	4.7	25	2.3	1/4	9	15
	265V-1-60	3.91	21	2.3	1/4	8	15
WSV6018*	208/230V-1-60	7.18	47	2.8	1/3	12	15
	265V-1-60	5.45	36	2.6	1/3	10	15
WSV6024*	208/230V-1-60	11.3	63	4.6	1/2	19	30
	265V-1-60	8.09	45	3.6	1/2	14	20
	208/230V-3-60	7.7	59.9	4.6	1/2	15	20
	460V-3-60	3.8	32.4	2.1	1/2	7	15
WSV6030*	208/230V-1-60	12.8	71	4.6	1/2	21	30
	265V-1-60	10.4	68	3.6	1/2	17	25
	208/230V-3-60	8.3	67.7	4.6	1/2	15	20
	460V-3-60	5.1	38.1	2.1	1/2	9	15
WSV6036*	208/230V-1-60	15.5	86	4.6	1/2	24	35
	265V-1-60	10.26	55	3.6	1/2	17	25
	208/230V-3-60	21.84	70	4.6	1/2	32	50
	460V-3-60	7.1	39	2.1	1/2	11	15
WSV6042*	208/230V-1-60	17.3	96	6.3	3/4	28	45
	208/230V-3-60	23.2	90	6.3	3/4	36	50
	460V-3-60	6.5	36	3.2	3/4	12	15
WSV6048*	208/230V-1-60	19.3	102	7.6	1	32	50
	208/230V-3-60	22.1	123	7.6	1	36	50
	460V-3-60	10.7	60	4	1	18	25
WSV6060*	208/230V-1-60	26.6	148	7.6	1	41	60
	208/230V-3-60	16.7	93	7.6	1	29	45
	460V-3-60	6.6	60	4	1	13	15
WSV6072*	208/230V-1-60	30.1	170	7.6	1	46	70
	208/230V-3-60	21.2	156.5	7.6	1	35	50
	460V-3-60	9.1	74.8	4	1	16	20

WSV6

VERTICAL WATER SOURCE HEAT PUMP

3/4 TO 6 TON UNIT

DATA TABLES

BLOWER DATA

MODEL NUMBER	FAN SPEED	RATED AIR-FLOW	CFM vs EXTERNAL STATIC PRESSURE (inches of water)									
			0.1	0.2	0.3	0.4	0.5	0.6	0.7	0.8	0.9	1.0
WSV6009	WHITE	330	380	360	330	300	270	250	---	---	---	---
	VIOLET		360	330	300	260	230	---	---	---	---	---
	GRAY		310	290	270	250	---	---	---	---	---	---
WSV6012	WHITE	430	470	450	430	400	370	340	310	---	---	---
	VIOLET		440	410	380	350	320	300	---	---	---	---
	GRAY		380	360	340	320	300	---	---	---	---	---
WSV6018	T3	600	730	700	660	630	590	550	520	---	---	---
	T2		610	580	540	500	460	---	---	---	---	---
	T1		540	510	480	450	---	---	---	---	---	---
WSV6024	T3	800	900	870	840	810	780	750	720	---	---	---
	T2		760	740	710	650	610	---	---	---	---	---
	T1		700	670	630	600	---	---	---	---	---	---
WSV6030	T3	925	1,160	1,130	1,100	1,070	1,040	1,010	980	950	930	900
	T2		1,040	1,000	980	940	900	870	840	810	---	---
	T1		940	910	870	830	800	760	---	---	---	---
WSV6036	T3	1150	1,380	1,350	1,320	1,290	1,270	1,240	1,210	1,180	1,150	1,120
	T2		1,130	1,090	1,060	1,030	1,000	970	---	---	---	---
	T1		1,060	1,030	990	960	---	---	---	---	---	---
WSV6042	T3	1330	1,420	1,400	1,370	1,340	1,320	1,290	1,260	1,230	1,200	1,170
	T2		1,330	1,300	1,270	1,240	1,220	1,190	1,160	1,130	---	---
	T1		1,190	1,160	1,130	1,100	---	---	---	---	---	---
WSV6048	T3	1500	1,660	1,630	1,620	1,580	1,560	1,520	1,490	1,460	1,430	1,400
	T2		1,550	1,530	1,510	1,480	1,450	1,420	1,390	1,360	1,330	1,300
	T1		1,370	1,350	1,330	1,290	1,260	---	---	---	---	---
WSV6048 Economizer	T3	1500	1,660	1,630	1,620	1,580	1,560	1,520	1,490	1,460	1,430	1,400
	T2		1,550	1,530	1,510	1,480	1,450	1,420	1,390	1,360	1,330	1,300
	T1		1,370	1,350	1,330	1,290	1,260	---	---	---	---	---
WSV6060	T3	1875	2,290	2,250	2,210	2,160	2,120	2,070	2,020	1,970	1,910	1,840
	T2		1,920	1,880	1,840	1,790	1,750	1,700	1,650	1,600	1,540	1,470
	T1		1,820	1,780	1,730	1,690	1,640	1,590	1,550	1,490	1,440	1,370
WSV6060 Economizer	T3	1875	2,290	2,250	2,210	2,160	2,120	2,070	2,020	1,970	1,910	1,840
	T2		1,920	1,880	1,840	1,790	1,750	1,700	1,650	1,600	1,540	1,470
	T1		1,820	1,780	1,730	1,690	1,640	1,590	1,550	1,490	1,440	1,370
WSV6072	T3	1900	2,290	2,250	2,210	2,160	2,120	2,070	2,020	1,970	1,940	1,910
	T2		2,140	2,100	2,060	2,010	1,970	1,920	1,870	1,820	1,760	1,690
	T1		1,990	1,950	1,910	1,860	1,820	1,770	1,720	1,670	1,610	1,540
WSV6072 Economizer	T3	1900	2,290	2,250	2,210	2,160	2,120	2,070	2,020	1,970	1,940	1,910
	T2		2,140	2,100	2,060	2,010	1,970	1,920	1,870	1,820	1,760	1,690
	T1		1,990	1,950	1,910	1,860	1,820	1,770	1,720	1,670	1,610	1,540

NOTE:

Airflow data shown is with a dry coil at 70°F DB EAT and with standard 1" filter.

WATER FLOW DATA

WATER FLOW PRESSURE DROP TABLE								
WSV6009*	Flow Rate (GPM)	1.0	2.0	3.0	4.0	5.0	6.0	7.0
	Pressure Drop (PSI)	0.2	0.9	1.9	3.0	4.5	6.3	8.2
WSV6012*	Flow Rate (GPM)	2.0	3.0	4.0	5.0	6.0	7.0	8.0
	Pressure Drop (PSI)	1.0	2.0	3.3	4.8	6.6	8.7	10.9
WSV6018*	Flow Rate (GPM)	2.0	3.0	4.0	5.0	6.0	7.0	8.0
	Pressure Drop (PSI)	1.0	2.0	3.3	4.8	6.6	8.7	10.9
WSV6024*	Flow Rate (GPM)	5.0	6.0	7.0	8.0	9.0	10.0	11.0
	Pressure Drop (PSI)	1.4	2.0	2.6	3.3	4.1	5.0	6.0
WSV6030*	Flow Rate (GPM)	6.0	7.0	8.0	9.0	10.0	11.0	12.0
	Pressure Drop (PSI)	2.3	3.0	3.9	4.8	5.8	6.9	8.0
WSV6036*	Flow Rate (GPM)	6.0	8.0	10.0	12.0	14.0	16.0	18.0
	Pressure Drop (PSI)	1.1	1.9	2.8	4.0	5.2	6.7	8.2
WSV6042*	Flow Rate (GPM)	7.0	9.0	11.0	13.0	15.0	17.0	19.0
	Pressure Drop (PSI)	1.4	2.1	3.0	4.1	5.2	6.6	8.0
WSV6048*	Flow Rate (GPM)	12.0	14.0	16.0	18.0	20.0	---	---
	Pressure Drop (PSI)	2.6	3.5	4.7	5.9	7.4	---	---
WSV6048* Economizer	Flow Rate (GPM)	12.0	14.0	16.0	18.0	20.0	---	---
	Pressure Drop (PSI)	6.5	8.8	11.8	14.8	18.5	---	---
WSV6060*	Flow Rate (GPM)	12.0	14.0	16.0	18.0	20.0	22.0	24.0
	Pressure Drop (PSI)	2.6	3.3	4.2	5.1	6.2	7.3	8.5
WSV6060* Economizer	Flow Rate (GPM)	12.0	14.0	16.0	18.0	20.0	22.0	24.0
	Pressure Drop (PSI)	6.0	8.2	10.6	13.4	16.5	19.9	23.7
WSV6072*	Flow Rate (GPM)	12.0	14.0	16.0	18.0	20.0	22.0	24.0
	Pressure Drop (PSI)	2.6	3.3	4.2	5.1	6.2	7.3	8.5
WSV6072* Economizer	Flow Rate (GPM)	12.0	14.0	16.0	18.0	20.0	22.0	24.0
	Pressure Drop (PSI)	6.0	8.2	10.6	13.4	16.5	19.9	23.7

WSV6

VERTICAL WATER SOURCE HEAT PUMP

3/4 TO 6 TON UNIT

DATA TABLES

CONNECTIONS, FILTERS & WEIGHTS DATA

Model Number	Water Connections	Condensate Connections	Nominal Filter Size H x W x QTY	Ship Weight
WSV6009	3/4" F.P.T.	3/4" F.P.T.	18 X 20 X 1	164
WSV6012	3/4" F.P.T.	3/4" F.P.T.	18 X 20 X 1	166
WSV6018	3/4" F.P.T.	3/4" F.P.T.	18 X 20 X 1	195
WSV6024	3/4" F.P.T.	3/4" F.P.T.	18 X 20 X 1	208
WSV6030	3/4" F.P.T.	3/4" F.P.T.	20 X 20 X 1	221
WSV6036	3/4" F.P.T.	3/4" F.P.T.	24 X 24 X 1	254
WSV6042	1" F.P.T.	3/4" F.P.T.	24 X 30 X 1	295
WSV6048	1" F.P.T.	3/4" F.P.T.	24 X 30 X 1	315
WSV6048 Economizer	1" F.P.T.	3/4" F.P.T.	14 X 24 X 2	340
WSV6060	1" F.P.T.	3/4" F.P.T.	18 x 24 x 1 20 x 24 x 1	360
WSV6060 Economizer			16 x 24 x 2	400
WSV6072	1" F.P.T.	3/4" F.P.T.	18 x 24 x 1 20 x 24 x 1	365
WSV6072 Economizer			16 x 24 x 2	405

WSV6

VERTICAL WATER SOURCE HEAT PUMP

3/4 TO 6 TON UNIT

DATA TABLES

TECHNICAL DATA

MODEL WSV6		Size										
		9	12	18	24	30	36	42	48	60	72	
Compressor	1 Each	Rotary					Scroll					
Refrigerant Type	R-454B											
Factory Charge lb [kg]		1.75 [.79]	1.80 [.82]	1.93 [.88]	2.14 [.97]	2.50 [1.13]	3.10 [1.41]	3.70 [1.68]	4.30 [1.95]	5.34 [2.42]	5.50 [2.49]	
A2L Sensor and Mitigation YES/NO		NO	NO	NO	NO	NO	NO	YES	YES	YES	YES	
Minimum Room Area Ft ² (m ²)		N/A	N/A	N/A	N/A	N/A	N/A	62 (6)	68 (6)	75 (7)	114 (11)	
Minimum Air Flow CFM (m ³ /hr)		N/A	N/A	N/A	N/A	N/A	N/A	111 (189)	123 (210)	135 (230)	205 (348)	
Motor	Type	ECM										
	Speeds	Multiple										
	HP [kw]	1/4 [.18]	1/4 [.18]	1/3 [.24]	1/2 [.37]	1/2 [.37]	1/2 [.37]	3/4 [.56]	1 [0.75]	1 [0.75]	1 [0.75]	
Blower Wheel in. [cm]	(D x W) (in) [cm]	6.75 x 7 [17.15 x 17.78]		9 x 7 [22.86 x 17.78]		10 x 8 [25.4 x 20.32]			11 x 10 [27.94 x 25.4]			
COAX Volume	(US Gallons)	0.116	0.144	0.144	0.359	0.432	0.533	0.624	0.88	0.88	1.084	
Water Connection FTP	(in)	3/4	3/4	3/4	3/4	3/4	3/4	1	1	1	1	
Condensate Connection FTP	(in)	3/4	3/4	3/4	3/4	3/4	3/4	3/4	3/4	3/4	3/4	
Air Coil Dimension	(W x H) (in) [cm]	16.38 x 18.13 [41.61 x 46.05]				16.25 x 20.13 [41.28 x 51.13]	20.88 x 24.13 [53.04 x 61.29]	20.88 x 28.13 [53.04 x 71.45]		20.88 x 36.13 [53.04 x 91.77]		
Standard TA Filter 1"	(W x H) (in) [cm]	18 x 20 [45.72 x 50.8]				20 x 20 [50.8 x 50.8]	24 x 24 [60.96 x 60.96]	24 x 30 [60.96 x 72.2]		18 x 24 [45.72 x 60.96] 20 x 24 [50.8 x 60.96]		
Filter	Qty	1	1	1	1	1	1	1	1	2	2	
Operating Weight	lbs	154 [70]	156 [71]	185 [84]	198 [90]	211 [96]	244 [111]	285 [129]	305 [138]	350 [159]	355 [161]	
Shipping Weight	[kg]	164 [74]	166 [75]	195 [88]	208 [94]	221 [100]	254 [115]	295 [134]	315 [143]	360 [163]	365 [166]	

WSV6

VERTICAL WATER SOURCE HEAT PUMP

3/4 TO 6 TON UNIT

DATA TABLES

TECHNICAL DATA (CONT'D)

MODEL WSV6		Size	
		090	120
Compressor	1 Each	Scroll	
Refrigerant Type		R-454B	
Factory Charge lb [kg]		10.14 [4.6]	11 [4.99]
A2L Sensor and Mitigation YES/NO		YES	YES
Minimum Room Area Ft ² (m ²)		150 (14)	165 (15)
Minimum Air Flow CFM (m ³ /hr)		271 (460)	298 (506)
Motor	Qty	1	
	Type	Direct	Belt
	HP Standard High Static	1.5 [2.0]	3.0 [5.0]
Blower	Qty	1	
	Blower Wheel Size (DxW) (in) [cm]	12 x 12 [30.48 x 30.48]	15 x 12 [38.1 x 30.48]
Coax Volume	(US Gallons)	1.50	1.68
Water Connection	Size FPT (in)	1 1/2	
Condensate Connection	Size FPT (in)	3/4	
Air Coil	Dimensions (W x H) (in) [cm]	40 x 32 [101.6 x 81.28]	40 x 40 [81.28 x 81.28]
	Face Area (ft ²)	8.89	11.11
Miscellaneous	Throwaway Filter Dimensions (in) [cm]	20 x 20 x 1 [50.8 x 50.8 x 2.54]	20 x 24 x 1 [50.8 x 60.96 x 2.54]
	Throwaway Filter Qty	4	4
	Weight - Operating (lbs.)	735	835
	Weight - Packaged (lbs.)	750	880
Notes: FPT = Female Pipe Thread			

WSV6

VERTICAL WATER SOURCE HEAT PUMP

ECONOMIZER UNIT

DATA TABLES

WSV6 ECONOMIZER UNIT

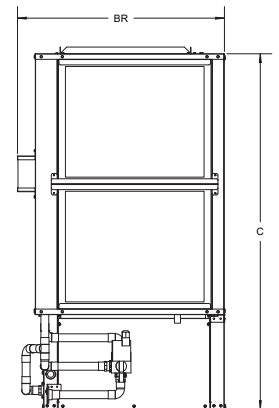
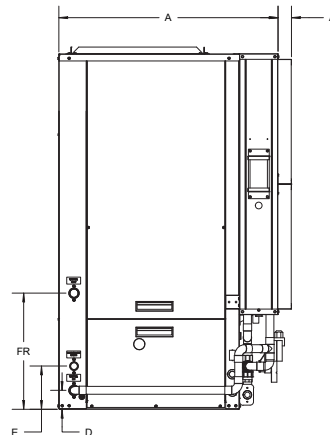
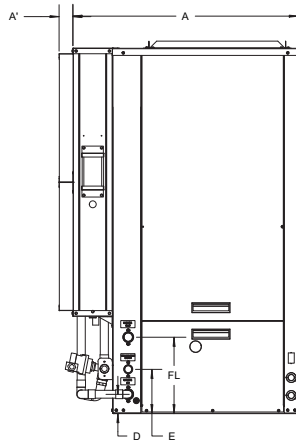
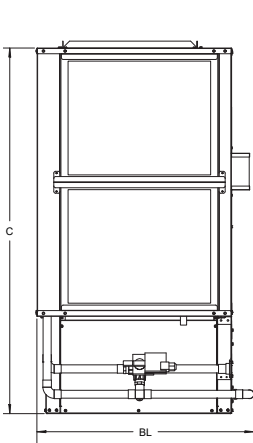
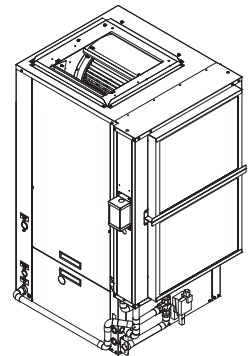
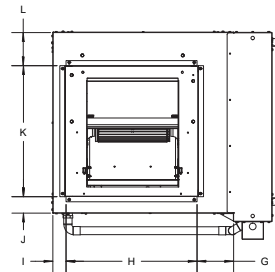
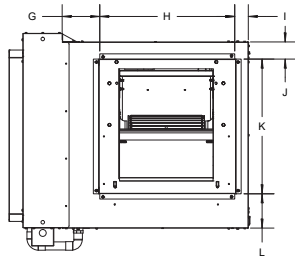
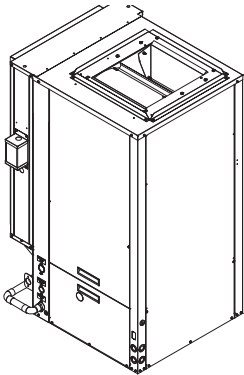
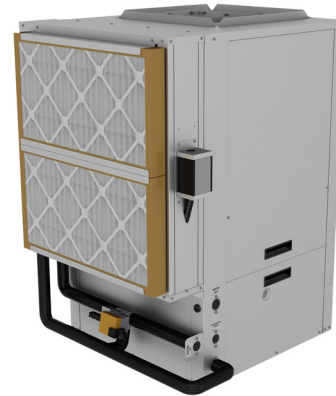

Left Hand Unit

Right Hand Unit

MODEL NUMBER	WSV6 ECONOMIZER DIMENSIONS														
	A	A'	B		C	D	E	F		G	H	I	J	K	L
		2"	L	R				L	R						
WSV6048 Economizer	31.59	1.91	30.39	29.82	43.16	2.72	6.22	10.72	16.72	5.25	18.88	1.92	2.38	18.88	4.77
WSV6060 Economizer	31.59	1.91	30.39	29.82	51.20	2.72	6.22	10.72	16.72	5.25	18.88	1.92	2.38	18.88	4.77
WSV6072 Economizer	31.59	1.91	30.39	29.82	51.20	2.72	6.22	10.72	16.72	5.25	18.88	1.92	2.38	18.88	4.77

WSV6 ECONOMIZER UNIT (CONT'D)

WSV6 ECONOMIZER PERFORMANCE DATA									
MODEL NUMBER	GPM	CFM	Pressure Drop PSI	Coil PD IWC	86° Deg. F / 68° Deg. F				
					Total MBH	Sensible MBH	Leaving Dry Bulb	Leaving Wet Bulb	Tempature Rise
WSV6048 Economizer	6	1200	2.0	0.18	34061	27638	59.1	58.1	11.2
		1400		0.22	36080	30473	60.3	59	11.9
		1600		0.28	37882	33030	61.3	59.7	12.4
	9	1200	3.8	0.18	39967	30172	57.2	56.4	8.8
		1400		0.23	42413	33349	58.4	57.5	9.3
		1600		0.29	44758	36327	59.4	58.3	9.8
	12	1200	6.6	0.19	43850	31874	55.9	55.3	7.2
		1400		0.24	46978	35280	57.2	56.4	7.7
		1600		0.30	46978	38398	58.3	57.2	8.1
WSV6060 Economizer	7.5	1500	2.4	0.15	42871	34689	59	58.1	11.3
		1750		0.19	45405	38295	60.2	58.9	11.9
		2000		0.23	47684	41532	61.2	59.6	12.5
	11.3	1500	5.4	0.16	50209	37870	57.1	56.4	8.8
		1750		0.20	53423	41802	58.4	57.4	9.4
		2000		0.23	56192	45616	59.3	58.2	9.9
	15	1500	9.3	0.16	54969	39966	55.9	55.3	7.2
		1750		0.20	59057	44264	57.1	56.3	7.8
		2000		0.24	62306	48209	58.2	57.2	8.2
WSV6072 Economizer	9	1800	3.4	0.20	49584	40625	59.5	58.4	10.9
		2100		0.25	52429	44762	60.7	59.3	11.5
		2400		0.31	55029	48472	61.7	59.9	12.1
	13.5	1800	7.6	0.21	57767	44222	57.7	56.9	8.4
		2100		0.26	61220	48819	58.9	57.9	8.9
		2400		0.32	64425	53112	59.9	58.6	9.4
	18	1800	13.4	0.21	62879	46489	56.6	55.9	6.9
		2100		0.27	67219	51408	57.8	56.9	7.4
		2400		0.32	70664	55982	58.9	57.8	7.7

NOTE: Cooling capacities based on 45°F entering water temperature.

WSV6

VERTICAL WATER SOURCE HEAT PUMP

7.5 – 10 TON UNIT

DATA TABLES

DIMENSIONS

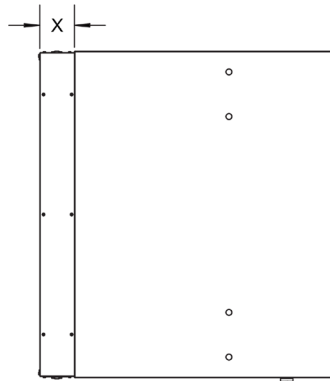

Side Discharge
Left Hand Unit

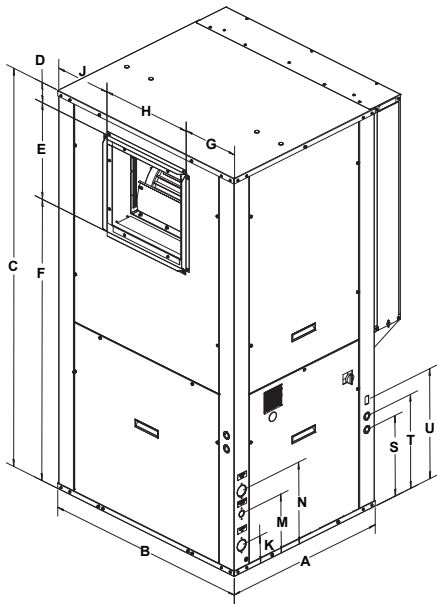

Straight Discharge
Right Hand Unit

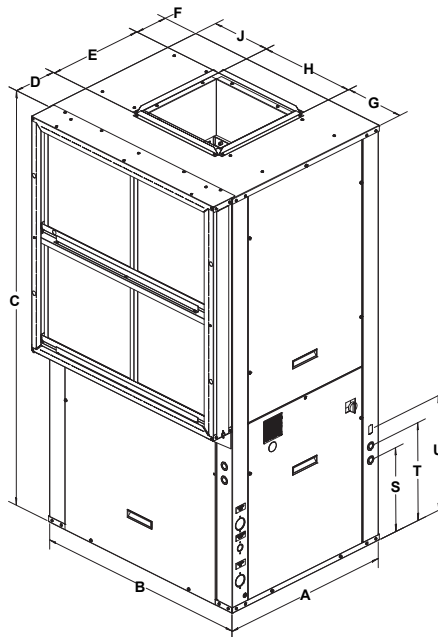

Top Discharge
Right Hand Unit

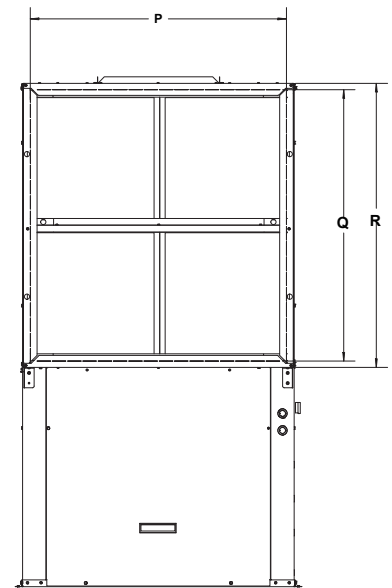

Side View (coil side)
Left Hand

DIMENSIONS (CONT'D)

Dimensions Reference/Description		MODEL NUMBER		
		WSV6090 (TOP)	WSV6090 (SIDE)	WSV6120 (TOP ONLY)
A	Width	32.0	32.0	32.0
B	Depth	40.0	40.0	48.0
C	Height	74.1	74.1	74.1
D		8.1	3.9	6.5
E	Duct	18.0	18.0	20.8
F		6.2	52.4	4.9
G		11.2	11.2	13.9
H	Duct	18.0	18.0	20.8
J		11.2	11.2	13.6
K	Water In	5.1	5.1	4.8
M	Condensate Drain	10.9	10.9	10.8
N	Water Out	15.2	15.2	16.3
P	R/A Duct Flange Width	39.9	39.9	47.8
Q	R/A Duct Flange Height	39.7	39.7	47.8
R	Filter Rack Height	41.8	41.8	41.8
S		15.0	15.0	14.9
T		17.5	17.5	17.4
U		20.5	20.5	28.9
V		20.0	20.0	19.9
W		32.3	32.3	32.3
	Condenser Water Connections	1-1/2" F. P. T.	1-1/2" F. P. T.	1-1/2" F. P. T.
	Condensate Connections	3/4" F. P. T.	3/4" F. P. T.	3/4" F. P. T.
	Nom. Filter Size	20 x 20 x 1 qty 4	20x 20 x 1 qty 4	20 x 20 x 1 qty 4
	Ship WT.	750	750	850

WSV6

VERTICAL WATER SOURCE HEAT PUMP

7.5 – 10 TON UNIT

DATA TABLES

PERFORMANCE DATA

MODEL	NOM. CFM	GPM	WATER LOOP (entering Water Temperature)				GROUND WATER (entering Water Temperature)			
			86°F		68°F		59°F		50°F	
			COOLING	EER	HEATING	COP	COOLING	EER	HEATING	COP
WSV6090	2680	25	93,000	16.1	89,000	4.3	101,000	22.0	73,000	3.9
WSV6120	3680	29	120,000	15.5	140,000	4.6	133,000	21.0	110,000	4.0

Tabulated performance data is at noted entering water temperature and entering air conditions of 80.6°F DB / 66.2°F WB at 208V CFM.

Note: Requires extended range temperature package

ELECTRICAL DATA

Model	Voltage	Compressor		Blower		MIN. CIRCUIT AMPACITY	MAX. CIRCUIT PROTECTION
		RLA	LRA	FLA	HP		
WSV6090*	208/230V-3-60	24.4	200	4.2	1.5	35	50
	460V-3-60	11.9	103	1.9	1.5	17	25
	208/230V-3-60	24.4	200	4.8	2	36	50
	460V-3-60	11.9	103	2.3	2	18	25
WSV6120*	208/230V-3-60	28.5	207.5	10.2	3	46	70
	460V-3-60	12.4	100.2	4.8	3	22	40
	208/230V-3-60	28.5	207.5	13.6	5	50	80
	460V-3-60	12.4	100.2	6.3	5	24	40

BLOWER DATA

MODEL NUMBER	FAN SPEED	MOTOR TERMINAL NO.	CFM vs EXTERNAL STATIC PRESSURE (inches of water)													
			0.1	0.2	0.3	0.4	0.5	0.6	0.7	0.8	0.9	1.0	1.1	1.2	1.3	1.4
WSV6090 1.5hp	HIGH	X1 + X2	---	---	---	---	---	---	---	2755	2670	2515	---	---	---	---
	MED.	X2	---	---	---	2900	2850	2800	2755	2705	---	---	---	---	---	---
	LOW	X1	---	2555	2300	1980	---	---	---	---	---	---	---	---	---	---
WSV6090 High Static 2.0hp	HIGH	X1 + X2	---	---	---	---	---	---	---	---	---	3225	3185	3140	3085	3025
	MED.	X2	---	---	---	---	---	2965	2845	2745	2655	2585	---	---	---	---
	LOW	X1	---	---	2820	2535	2200	---	---	---	---	---	---	---	---	---

BELT DRIVE														
AIRFLOW (SCFM)	DESCRIPTION	ESP (in. wg)												
		0.2	0.4	0.6	0.8	1.0	1.2	1.4	1.6	1.8	2.0			
3000	RPM	561	624	684	743	800	855	909	960	1010	1058			
	BHP	0.7	0.8	0.9	1.0	1.2	1.3	1.5	1.6	1.8	2.0			
	TURNS OPEN (±0.5)	5.0	3.5	3.0	4.0	2.0	4.0	2.5	1.0	3.5	2.0			
3500	RPM	623	676	729	781	832	883	933	982	1031	1079			
	BHP	0.9	1.0	1.2	1.4	1.5	1.7	1.8	2.0	2.2	2.3			
	TURNS OPEN (±0.5)	4.0	3.5	2.0	2.5	1.0	3.5	2.0	4.0	2.5	1.5			
4000	RPM	673	727	778	828	876	922	966	1007	1047	1085			
	BHP	1.3	1.5	1.6	1.8	2.0	2.1	2.3	2.5	2.7	2.9			
	TURNS OPEN (±0.5)	3.5	2.0	2.5	1.5	3.5	2.0	1.0	3.5	2.0	1.0			
4500	RPM	732	784	833	881	926	969	1010	1049	1087	1121			
	BHP	1.8	1.9	2.1	2.3	2.5	2.7	3.0	3.2	3.4	3.6			
	TURNS OPEN (±0.5)	1.5	2.5	1.0	3.5	2.0	1.0	3.5	2.0	1.0	0.0			
								STANDARD MOTOR - 3 HP					OPTIONAL HIGH STATIC MOTOR - 5 HP	

NOTE:

Air flow data shown is with a dry coil at 70°DB EAT with Standard 1" filter.

WSV6

VERTICAL WATER SOURCE HEAT PUMP

SPECIFICATION GUIDE

GENERAL

Equipment is completely assembled, piped, internally wired, fully charged with R454B refrigerant and factory tested. Filters, thermostat field interfaces, and all safety controls shall be factory installed.

Units shall be capable of operating over entering fluid temperature ranges of 50°- 110° in cooling mode and 50°- 90° in heating mode in standard configuration. The extended range option extends unit operating range to 20°- 120° in cooling mode and 20° - 90° in heating mode.

UNIT CONSTRUCTION CONFIGURATIONS

Vertical units are configurable in the following arrangements:

7.5 thru 10 tons - left return/top supply, left return/side supply, right return/top supply, right return/side supply.

For side discharge configurations, the supply side connection is on the opposite side of the unit finned tube heat exchanger.

3/4 thru 6 tons - left return/top supply, right return/top supply.

For all systems, water, refrigerant and electrical connections are accessible from the front service access panel.

CABINET CONSTRUCTION

Units are built with a corner post and base design using a minimum of 18 gauge galvanized steel on any weight bearing component. Corner posts and panels are designed to allow for service access to all internal components. Structural integrity of the cabinets is unaffected by the removal of any or all of the access panels.

Air handling section interior surfaces are lined with 1" thick foil faced insulation.

The condensing section interior surfaces are lined with 1" of fiberglass insulation on the condensing section access panel, base pan, mid pan, and all lower access panels.

SERVICE CONNECTIONS

Water connections are accessible from the front of the unit. Water connections shall be made through factory installed brass FPT fittings which will be flush to the water panel. The water fittings shall be rigidly attached to the corner posts to forgo the use of a backup wrench when connecting the supply water.

SUPPLY AIR CONNECTIONS

Vertical systems have 1" integral supply duct collars to allow for connection of the supply duct. All duct collars are installed on the unit from the factory.

FILTER RACK

Vertical systems come standard with a 2" filter frame factory installed. The filter frame encloses the filter on all four sides to prevent air bypass around the filter. The filter frame provides tool-less access to the filters for replacement. The filter rack has integrated duct flanges for ducted applications. An option 4" filter frame may also be configured.

DRAIN PAN

The **7.5 thru 10 ton** units use a stainless steel drain pan while the **3/4 thru 6 ton** units use a thermoplastic drain pan. Both pans will increase corrosion resistance. The drain pan will be internally two-way sloped, with the drain port located near the front of the unit. The unit comes standard with an electronic condensate overflow sensor attached to the edge of the drain pan.

WSV6

VERTICAL WATER SOURCE HEAT PUMP

REFRIGERATION CIRCUIT

GENERAL

All systems use R454B refrigerant. All units have factory charged refrigeration circuits, each with its own compressor, reversing valve, bi-flow TXV, coaxial heat exchanger and finned tube refrigerant to air heat exchanger. Each circuit includes a high pressure switch, low pressure switch, and heat exchanger freeze sensors. The circuits each have a high-side and low-side Schrader valve to allow for service access to the refrigeration systems. All service ports are accessible from the front of the unit.

COMPRESSOR

All systems use a high efficiency scroll compressor. The scroll compressor is attached to a heavy gauge double-isolated compressor mounting plate to dampen vibration throughout the system.

For additional sound attenuation, an optional sound package is available which offers a compressor blanket.

COAXIAL HEAT EXCHANGER

The systems use one high efficiency coaxial heat exchanger. The coaxial heat exchanger is designed for working refrigerant pressures up to 600psi and working water pressures up to 400psi. The heat exchanger is coated in an epoxy resin to protect against corrosion.

Optional curpronickel coaxial heat exchangers are offered to provide additional corrosion resistance in certain hard water and open loop applications.

REVERSING VALVE

A system reversing valve (4-way valve) is included with all heat pump systems. The valve is piped to be energized in cooling mode to provide heat if a valve failure were to occur. Once the valve is energized in cooling mode, it will remain energized as long as the O call is provided to the unit control board.

THERMOSTATIC EXPANSION VALVE

Each independent refrigeration circuit has its own balanced port, externally equalized bi-flow thermostatic expansion valve. The thermostatic expansion valve has sweat connections on the inlet/outlet and feature a screw on equalizer port connection.

EVAPORATOR COIL

Internally finned, 3/8-inch copper tubes mechanically bonded to a configured aluminum finned plate is standard. Coils are leak tested at the factory to ensure the pressure integrity. The coils are leak tested to 450 psig and pressure tested to 650 psig. The tubes are completely evacuated of air and correctly charged with proper volume of refrigerant prior to shipment. The refrigerant coil distributor assembly is of orifice style with round copper distributor tubes. The tubes are sized consistently with the capacity of the coil. Suction header is fabricated from round copper pipe.

FAN BLOWER (7.5 THRU 10 TON UNITS ONLY)

System includes either a forward curve direct drive fan with ECM motor or a belt driven forward curve fan with premium duty motor. The standard fan blower assemblies are designed to supply a nominal 400 CFM/ton at maximum of 1.5" of external static. Ratings for the fan blowers are done with a dry coil and with a standard 1" Merv 5 filter.

Optional high static motors are available to provide additional static range up to 2" of external static pressure at nominal 400 CFM/ton.

WSV6

VERTICAL WATER SOURCE HEAT PUMP

REFRIGERANT OPTIONS

3/4 THRU 6 TON UNITS

Internally finned, 3/8-inch copper tubes mechanically bonded to a configured aluminum finned plate is standard. Coils are leak tested at the factory to ensure the pressure integrity. The coils are leak tested to 450 psig and pressure tested to 650 psig. The tubes are completely evacuated of air and correctly charged with proper volume of refrigerant prior to shipment. The refrigerant coil distributor assembly is of orifice style with round copper distributor tubes. The tubes are sized consistently with the capacity of the coil. Suction header is fabricated from rounded copper pipe.

HGRH ON/OFF (7.5 THRU 10 TON UNITS)

Units may be configured with an optional hot gas reheat to provide for additional space dehumidification during the cooling mode. The HGRH circuit adds an additional reheat coil in the air stream, reheat solenoid valve, and check valve.

For systems with multiple refrigeration circuits, only the primary circuit will have the HGRH circuit.

The reheat coil circuit will be controlled via the DH terminal, which must be wired to an external humdistat to provide dehumidification call to enable hot gas reheat mode. During this mode, the reheat valve diverts some hot refrigerant to the reheat coil while the rest of hot refrigerant flow into the coaxial heat exchanger. The 2-phase refrigerant from the reheat coil and liquid refrigerant from the coaxial heat exchanger rejoin before entering the evaporator. When the call for dehumidification is removed, the reheat solenoid valve will close to divert all refrigerant flow through the coaxial coil.

ELECTRICAL AND CONTROLS

(3/4 THRU 6 TON UNITS)

VPC (Vacated Premises Control) - Allows the unit to operate for either 1 or 2 hours a day (total) during extended periods of un-occupancy (requires optional kit).

Nuisance Trip Protection - Unit will attempt to start up to three times with a fault signal. If the fault continues, the unit locks out.

DIP SWITCHES

(FIELD SELECTABLE SETTINGS):

- 5 Second Compressor Delay- Blower starts before the compressor, which helps attenuate compressor start up sound.
- 45 Second Blower Off Delay - Increases cooling efficiency.
- VPC Switch - Selects either one or two hour daily operation (requires optional kit).
- Lower Water and Air Coil Temperature Cutout Options - Optional 10°F cutouts for applications where water temperature is below 50°F (requires antifreeze solution).
- Two Accessory Relays - The relays can cycle with either the fan or compressor. In addition, relay number one can be configured for use with a slow opening water valves (60 second pre-compressor initialization) and relay number two can be configured for a 30 second post fan delay.

WSV6

VERTICAL WATER SOURCE HEAT PUMP

GENERAL

All units have a control box mounted in the condensing section compartment which houses all necessary electrical components for unit operation. This control box serves as the location for wiring of the high voltage and low voltage circuits for unit operation.

The unit is controlled via 24V low voltage terminals, which connects to an external thermostat or controller which will control the heating and cooling provided by the unit.

The electrical control box contains the following components.

1. Compressor Contactors
2. Blower motor contactors
3. Control Board
4. Low Voltage Wiring Connections
5. High Voltage terminal block
6. 24V Transformer for low voltage control
7. Phase monitor
8. High Voltage Disconnect Switch
9. Ground Connection

WATER SOURCE CONTROL MODULE

All units will come standard with a WSCM electromechanical module that will control unit operation and contain safety features to protect the compressors, coaxial heat exchangers and fin-tube heat exchangers. The board will contain the following features:

1. Two-stage cooling and two-stage heating control modes for optimal temperature and
2. Anti-short cycle protection
3. Random Start
4. High and Low Pressure Safeties
5. Water Coil Freeze Protection
6. Air-coil Freeze protection
7. Over/under voltage protection
8. Fault Retry
9. Lockout with soft and hard reset
10. Condensate overflow sensor
11. Diagnostic LED display
12. Test Mode
13. Alarm Relay
14. Accessory Relays
15. Option Delays





AMERICAN-MADE. FAMILY OWNED.



FIRST CO.
P.O. BOX 270969 - DALLAS, TEXAS 75227
PH. (214) 388-5751 | FAX (214) 388-2255
WWW.FIRSTCO.COM

NOVEMBER 2024