



FIRST CO.  
P.O. BOX 270969 - DALLAS, TEXAS 75227  
PH. (214) 388-5751 | FAX (214) 388-2255  
WWW.FIRSTCO.COM

**WSHC/WSHX Series**  
Horizontal (1.5 thru 5 tons)



# WSHC/WSHX Series *HORIZONTAL*

## STANDARD FEATURES

**Unit Cabinet-** Fabricated from a minimum of 18 gauge galvanized steel with a durable baked-on powder coat finish. Post and panel construction allows for large access panels to permit full access to internal components. The structural integrity of the cabinets remain unaffected by the removal of any or all access panels.

**Cabinet Insulation-** The cabinets are insulated with ¾" Tuf-Skin RX™, which offers greater sound absorption and better thermal efficiency. The insulation has a special acrylic coating that's formulated with an EPA registered anti-microbial agent.



**Evaporative Coils, R-410A Refrigerant-** 3/8" inch staggered tube type construction with seamless copper tubes, and deep corrugated aluminum fins with straight edges. Fins are manufactured with full depth collars, drawn in the fin stock to provide accurate control of fin spacing and completely cover the copper tubes to lengthen coil life. The tubes are mechanically expanded into the fins for a permanent primary to secondary surface bond, assuring maximum heat transfer efficiency.

**Coaxial Heat Exchanger-** Features a tube in tube coaxial water-to-refrigerant heat exchanger and constructed of a convoluted copper (optional cupronickel) inner tube and steel outer tube with a designed refrigerant working pressure of 450 PSIG (3100 kPa) and designed water side working pressure of no less than 400 PSIG (2750 kPa)

**FPT Water Connections-** Panel-mounted female pipe thread- No back-up wrench needed.

**Service Ports-** High side and low side service ports.

**Drain pans-** Made from an UL94-5V rated, rigid PVC Non-corrosive material with a three-way slope for positive drainage.

**Blower assemblies-** Wheels are double width, double inlet (DWDI), forward curved, centrifugal type. They are statically and dynamically balanced for a smooth, quiet operation. The Class I housing is constructed of heavy gauge steel with die-formed inlet cones. Assemblies are field reversible to optimize blower performance.

**Motors-** Multi-speed, 230V, single phase, 60-Hz, permanent split capacitor (PSC) type, are factory mounted to the blower assembly with rubber isolators.

**Compressor-** Unit contains a high efficiency rotary or scroll compressor. External vibration isolation is provided by rubber mounting devices located underneath the mounting base of the compressor. Internal thermal overload protection is provided. Protection against excessive discharge pressure is provided by means of a high pressure switch. A loss of charge is provided by a low pressure safety.

**Reversing Valve-** A system reversing valve (4-way valve) is included with all heating/cooling units. This valve is piped to be energized in the cooling mode to allow the system to provide heat if valve failure were to occur. Once the valve is energized for cooling, it will remain energized until the control system is turned to the OFF position, or a heating cycle is initiated. Units with the cooling only option will not receive a reversing valve.

**Removable discharge duct flange-** Provides additional installation flexibility.

**Filter Section-** Includes 1" disposable type fiberglass filters. The 1" filter section can be field mounted to the cabinet after unit has been installed with an easy tool free design.

**Digital Control Module (DCM)-** Controls unit operation and monitors all safety controls. (Patent Pending)

**Refrigerant circuit-** Features a filter-drier and a discharge muffler for quiet operation.

**50 VA Transformer-** Assists in accommodating accessory loads.

**100% Factory performed run test-** Every unit is run test prior to packaging.

# WSHC/WSHX Series

## HORIZONTAL WATER SOURCE HEAT PUMPS

### OPTIONS

**Electric Heat 208-230/1/60** -Discharge mounted electric heat available with various Kw's and options.

**Spring Isolators**-Kits are available by unit size

**Vacated Premises Control (VPC) with reset feature**-Ensures the unit will operate a minimum of one or two hours per day during extended periods of none occupancy. This option also includes an automatic reset feature. If a fault occurs, the system will shut down, but then automatically reset every 24 hours. If the same fault exists each day, the unit will lockout on the fourth day and have to be manually reset.

**Cupronickel Coaxial Heat Exchanger**-Features a tube in tube coaxial water-to-refrigerant heat exchanger and constructed of a convoluted cupronickel inner tube and Steel outer tube with a designed refrigerant working pressure of 450 PSIG (3100 kPa) and designed water side working pressure of no less than 400 PSIG (2750 kPa)

**E-Coat-Coil** will have a flexible epoxy polymer e-coat uniformly applied to all coil surface areas with no material bridging between fins. The coating process will ensure complete coil encapsulation and a uniform dry film thickness from 0.6 – 1.2 mils on all surface areas, including fin edges and meet 5B rating cross-hatch adhesion per ASTM B3359-93.

**Evaporator Temperature Sensor (ETS)**-Prevents freezing evaporator during low ambient conditions.

## GUIDE SPECIFICATIONS

### General

Equipment shall be completely assembled, piped, internally wired, fully charged with R-410A refrigerant and test operated at the factory. Filters, thermostat field interface terminal strip, and all safety controls are furnished and factory installed. The system water inlet and outlet connections shall be female NPT panel-mounted - No back-up wrench needed. The 5-ton and below equipment shall contain ETL, CETL and ISO-ARI 13256-1 listings and labels prior to leaving the factory.

### Air-to-Refrigerant Coil

Internally finned, 3/8-inch copper tubes mechanically bonded to a configured aluminum plate fin shall be standard. Coils shall be leak tested at the factory to ensure the pressure integrity. The coil shall be leak tested to 450 psig and pressure tested to 650 psig. The tubes are to be completely evacuated of air and correctly charged with proper volume of refrigerant prior to shipment. The refrigerant coil distributor assembly shall be of orifice style with round copper distributor tubes. The tubes shall be sized consistently with the capacity of the coil. Suction header shall be fabricated from rounded copper pipe. A thermostatic expansion valve shall be factory selected and installed for a wide range of control.

### Reversing Valve

A system reversing valve (4-way valve) is included with all heating/cooling units. This valve is piped to be energized in the cooling mode to allow the system to provide heat if valve failure were to occur. Once the valve is energized for cooling, it will remain energized until the control system is turned to the OFF position, or a heating cycle is initiated. Units with the cooling only option will not receive a reversing valve.

### Automatic Flow Devices (option)

The automatic flow kit shall contain a Hays Mesurflo® automatic flow control valve, two ball valves, two flexible hoses, a high flow Y-strainer, and may include a strainer

blow-down and various other accessories. The automatic flow control valve shall be factory set to a rated flow, and shall automatically control the flow to within 10% of the rated value over a 40 to 1 differential pressure, operating range (2 to 80 PSID). Operational temperature shall be rated from fluid freezing, to 225°F. The valve body shall be constructed from hot forged brass UNS C37700 per ASTM B-283 latest revision. For more information pertaining to the automatic balancing hose kits, see literature documentation

### Ball Valves (option)

Ball valves shall be field installed between the unit and the supply and return lines of the loop to stop water flow to the unit in a maintenance or service situation.

### Cabinet

Fabricated from a minimum of 18 gauge galvanized steel with a durable baked-on powder coat finish. Post and panel construction allows for large access panels to permit full access to internal components. The structural integrity of the cabinets shall remain unaffected by the removal of any or all access panels. All panels shall be insulated with 3/4" Tuf-Skin RX™, which offers greater sound absorption and better thermal efficiency. Insulation to have a special acrylic coating that's formulated with an EPA registered anti-microbial agent. The insulation meets the erosion requirements of UL 181. It has a flame spread of less than 25 and a smoke developed classification of less than 50 per ASTM E-84 and UL 723. Access for inspection and cleaning of the unit drain pan, coils and fan section shall be provided. The unit shall be installed for proper access.

### Compressors

Unit contains a high efficiency rotary or scroll compressor. External vibration isolation is provided by rubber mounting devices located underneath the mounting base of the compressor.

*Continues on the next page*

## GUIDE SPECIFICATIONS (CONT.)

Internal thermal overload protection is provided. Protection against excessive discharge pressure is provided by means of a high pressure switch. A loss of charge is provided by a low pressure safety.

### Basic Controls

Units shall include the following controls and functions. Service test mode with diagnostic LED shall allow service personnel to check the operation of the WSHP and control system efficiently. Upon entering Test mode, time delays speed up, and the Status LED displays a code to indicate the last fault experienced. This mode provides easy fault diagnosis; based on the fault code that the status LED displays.

**24V Status LED** - Green light indicates 24V power to the control module.

**VPC (Vacated Premises Control)** – Shall allow the unit to operate for either 1 or 2 hours per day (total) during extended periods of no occupancy. (requires optional kit).

**Nuisance Trip Protection** - Unit will attempt to start up to three times with a fault signal. If the fault continues, the unit locks out.

**Condensate overflow lock out** - an electronic sensor mounted to the drain pan. When condensate pan liquid reaches an unacceptable level, the unit is automatically deactivated and placed in a lockout condition.

**Provide High and Low Pressure Switches.**

**Provide condenser coil low temperature protection** - high / low voltage protection because of high or low voltage conditions.

Provide a random re-start timer to ensure a random delay in energizing each different WSHP unit to minimize peak electrical demand during start-up from different operating modes or after building power outages. Provide the circuit board with conformal coating (both sides of board) for

humidity and condensation protection.

**Provide Anti-short Cycle Timer, Alarm Relay** - Activated if the unit locks out.

**Field selectable settings:**

**5 Second Compressor Delay** - Blower starts before the compressor, attenuates compressor start up sound.

**45 Second Blower-off Delay** - Increases cooling efficiency.

**Continuous Dehumidification Mode** - Selects continuous low speed fan operation for increased humidity removal.

**Provide the following, low water temperature and low coil temperature cutout options**–Optional 10 degree F. cutouts for applications where water temperature is below 50 degrees F. (requires antifreeze solution).

**Accessory Relays (2)** - Relays can be selected to cycle with either the fan or compressor.

Relay “1” can be configured for use with slow opening water valves (60 second pre-compressor initialization) and relay “2” can be configured for a 30 second post fan delay.

### Drain Pan

The condensate pan shall be constructed of corrosion proof material. The bottom of the drain pan shall be sloped on two planes which pitches the condensate to the drain connection. The drain pan shall be flame rated per UL945V-B.

### Electrical

The unit control box shall contain all necessary devices to allow heating and cooling operation to occur from a remote wall thermostat. These devices shall be as follows:

## GUIDE SPECIFICATIONS (CONT.)

### **24 VAC energy limiting class II [50 VA (minimum) transformer]**

### **24 VAC blower motor relay**

### **24 VAC compressor contactor for compressor control**

Thermostat connections shall be provided for ease of hook-up to a terminal strip located in the unit's control box.

### **Electric Heat (option)**

Boilerless control electric heat shall be field supplied and wired to WSHP control panel. It shall be composed of a nichrome open wire coil designed for 2-kW per unit ton. The design consist of a single stage of electric heat used as a primary heating source when compressor lockout has occurred due to the entering water temperature falling below 55°F with an adjustable range between 25°F to 60°F. The electric heat option is not intended for secondary heat.

### **Filters**

One inch filters shall be standard and factory installed.

### **Hoses (option)**

Hoses shall consist of a stainless steel outer braid with an inner core of tube made of a nontoxic synthetic polymer material. The hoses shall be suitable for water temperatures ranging between 33°F and 211°F without the use of glycol.

Indoor Blower Wheels are double width, double inlet (DWDI), forward curved, centrifugal type. They are statically and dynamically balanced for a smooth, quiet operation. The Class I housing is constructed of heavy gauge steel with die-formed inlet cones. Assemblies are field reversible to optimize blower performance.

Motors to be multi-speed, 230V, single phase, 60-Hz, permanent split capacitor (PSC) type, factory mounted to the blower assembly with rubber isolators.

### **Motorized Water Valve (option)**

When extreme fluid temperature conditions do not exist with an open loop system, a motorized water valve shall be applied to each water-source heat pump. The motorized valve shall stop flow to the unit, causing pressures to rise. This rise in pressure will halt pump operation to provide greater energy savings of the entire system.

### **Pump Module (option)**

The pump module shall be a complete self contained pumping package for an earth-coupled heat pump system. The module shall consist of a single bronze pump, and a brass 3-way shut-off valve. These kits shall contain the necessary components for the installation, operation, and maintenance of the water circuit of a closed-loop distributed pumping application.

### **Refrigerant Circuits**

The refrigerant circuit shall contained a thermal expansion device. Service pressure ports shall be factory supplied on the high and low pressure sides for easy refrigerant pressure or temperature testing.

### **Refrigerant Tubing**

The refrigerant tubing shall be copper. This system shall be free from contaminants and conditions such as drilling fragments, dirt and oil.

## GUIDE SPECIFICATIONS (CONT.)

Coaxial Heat Exchanger, features a tube in tube coaxial water-to-refrigerant heat exchanger and constructed of a convoluted copper (optional cupronickel) inner tube and steel outer tube with a designed refrigerant working pressure of 450 PSIG (3100 kPa) and designed water side working pressure of no less than 400 PSIG (2750 kPa)

**Control Module and Safety Devices:** The WSH\* unit comes standard with a control module that controls the units operation and monitors the safety controls that protect the compressor, heat exchanger, wiring and other components from damage caused by operating outside of design conditions.

Safety controls include the following:

-High pressure switch located in the refrigerant discharge line.

-Low pressure switch located in the refrigerant suction line.

-Water coil low temperature cutout sensor located on the heat exchanger to prevent unit operation below low temperature setting.

- Condensate overflow protection sensor located in the drain pan.

The control module includes the following features:

**-Anti-Short Cycle Timer** - 5 minute anti-short cycle protection for the compressor.

NOTE: THE 5 MINUTE ANTI-SHORT CYCLE ALSO OCCURS AT POWER UP.

**-Random Start** - The controller features a 5-80 second random start upon power up.

**-Low Pressure Bypass Timer** - The low pressure switch input is bypassed for the initial 120 seconds of a compressor run cycle to prevent nuisance low pressure lockouts.

**-Over / Under Voltage Shutdown** - Should a Over / Under Voltage condition be detected, the module will initiate a shutdown.

Over / Under Voltage Shutdown is self resetting in that if the voltage comes back with range of 18.5VAC to 31VAC, then normal operation will be restored.

**-Alarm Relay** - The module has a set of contacts for remote fault indication. Contacts can be 24VAC output or converted to a dry contact.

**-Test Mode** - Test pins can be momentarily jumpered to enter into a 10 minute test mode period in which all time delays are sped up to 15 times. While in the test mode the LED Display will display a code representing the last fault in memory.

**NOTE: CONTINUED OPERATION OF THE UNIT IN THE TEST MODE CAN LEAD TO ACCELERATED WEAR AND PREMATURE FAILURE OF UNIT.**

**Fault Retry** - While in the fault retry mode the LED Display will display a code representing retry and the fault code. The unit will initiate the anti-short cycle timer and try to restart after the delay. If 3 consecutive faults occur without satisfying the thermostat the control will go to lockout mode. The last fault causing the lockout will be stored in memory and displayed.

**-Lockout** - While in the lockout mode the LED Display will display a code representing lockout and the fault code.



## GUIDE SPECIFICATIONS (CONT.)

The compressor relay is turned off immediately. During a lockout mode the alarm relay is activated. Lockout mode can be soft reset by turning the thermostat to the “OFF” position then back to the “HEAT” or “COOL” mode or hard reset via the power disconnect.

**-LED Indication** - Two LED indicators are provided as follows:

**Green:** Power LED indicates 18.5 - 31 VAC is present at the board.

**Yellow:** Test LED indicates the unit is operating the test mode.

**-LED Display** - A two digit display indicates the system

mode and fault code, if present. See table 1 in installation instructions.

## NOMENCLATURE

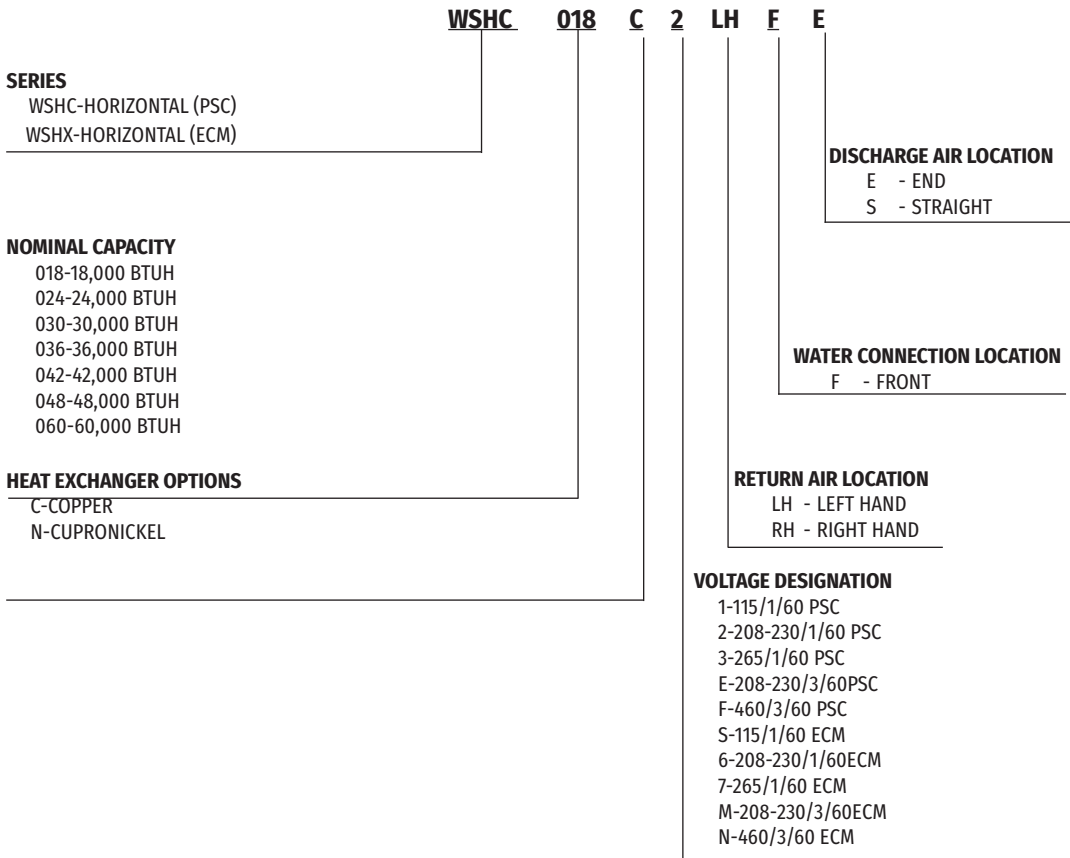



# PHYSICAL DATA

## ELECTRICAL AND PIPING LOCATIONS

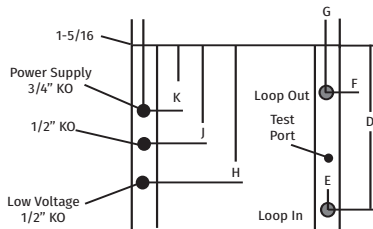

SIZE	CONDENSATE	
	3/4" FPT	
	AA	BB
018	3-3/8	1-1/8
024	3-3/8	1-1/8
030	3-3/8	1-1/8
036	3-3/8	1-1/8
042	3-3/8	1-1/8
048	3-3/8	1-1/8
060	3-3/8	1-1/8

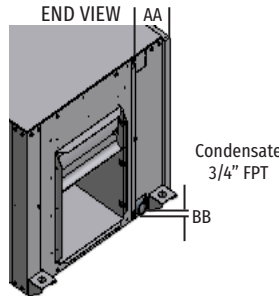
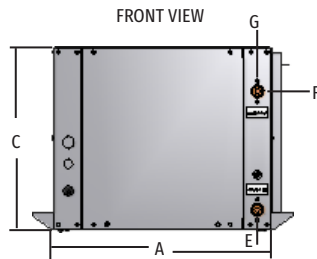

## TOP VIEW MOUNTING LOCATIONS

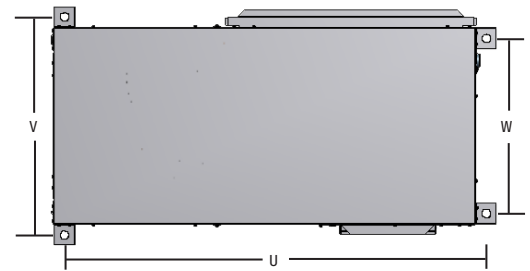

## LEFT RETURN / END DISCHARGE

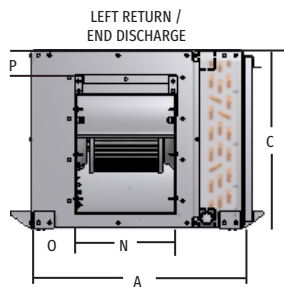
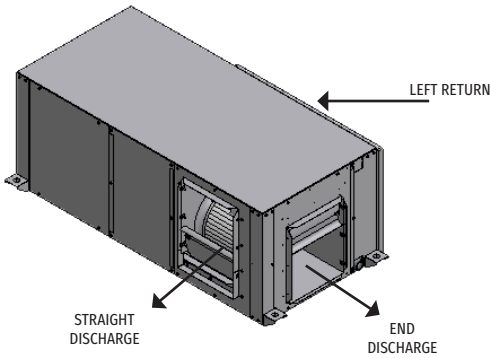

**MUST SELECT EITHER END DISCHARGE OR STRAIGHT DISCHARGE**

## RIGHT RETURN / END DISCHARGE

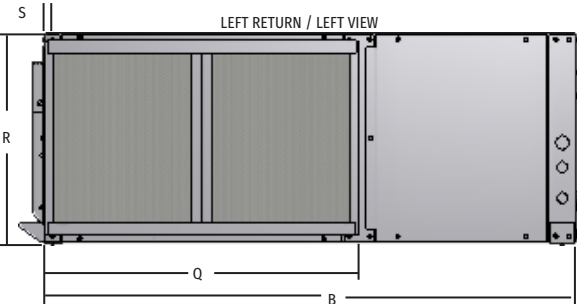
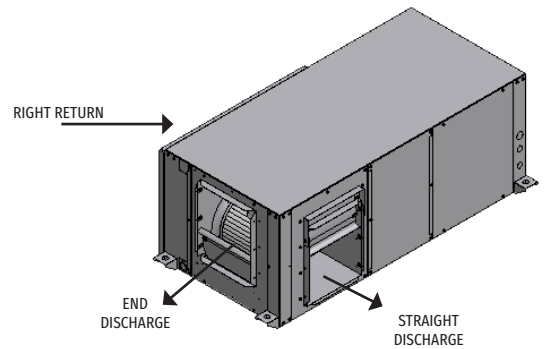

LEFT RETURN / STRAIGHT DISCHARGE

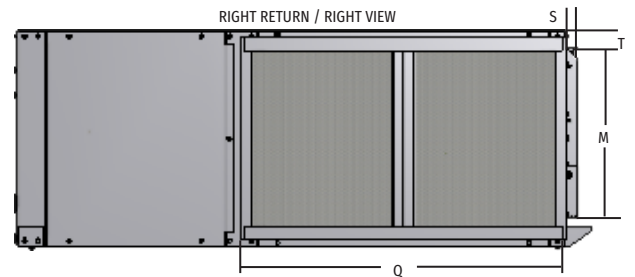

## RIGHT RETURN / STRAIGHT DISCHARGE

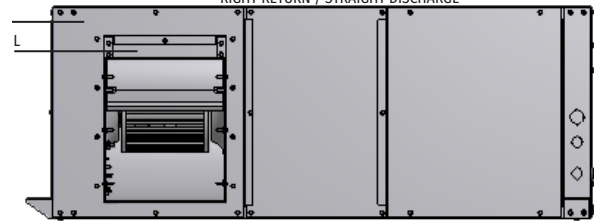

SIZE	OVERALL CABINET			CONNECTIONS				LOOP IN/OUT FPT	ELECTRIC KNOCKOUT			DISCHARGE DUCT FLANGE					RETURN DUCT FLANGE				MOUNTING BRACKET CENTER DISTANCES		
	W	L	H	LOOP IN		LOOP OUT			H 1/2"	J 1/2"	K 3/4"	L	M	N	O	P	Q	R	S	T	U	V	W
				D	E	F	G																
018	20-1/8	43-1/8	17	15-1/8	1-1/4	4-1/8	1-1/4	3/4"	13-3/8	10-7/8	8-7/8	2-5/16	13-5/16	9-7/8	4-1/8	1-5/16	23	15	1-1/4	1	43	22-1/4	17-3/4
024	20-1/8	43-1/8	18-1/4	16-1/2	1-1/4	4-7/16	1-1/4	3/4"	14-5/8	12-1/8	10-1/8	3-5/8	13-5/16	9-7/8	4-3/16	1-5/16	23	16-1/4	1-1/4	1	43	22-1/4	17-3/4
030	20-1/8	43-1/8	18-1/4	16-1/2	1-1/4	3-1/8	1-1/4	3/4"	14-5/8	12-1/8	10-1/8	3-5/8	13-5/16	9-7/8	4-3/16	1-5/16	23	19	1-1/4	1	43	22-1/4	17-3/4
036	20-1/8	47-1/8	21	19-1/8	1-1/4	5-3/4	1-1/4	3/4"	17-3/8	14-7/8	12-7/8	2-1/2	16-1/8	10-7/8	3	2-5/16	25-1/2	19	1-1/4	1	47	22-1/4	17-3/4
042	20-1/8	47-1/8	21	19-1/8	1-1/4	4-3/4	1-1/4	3/4"	17-3/8	14-7/8	12-7/8	2-1/2	16-1/8	10-7/8	3	2-5/16	25-1/2	19	1-1/4	1	47	22-1/4	17-3/4
048	24-1/8	54-1/8	21	19-1/8	1-1/4	4-7/16	1-1/4	1"	17-3/8	14-7/8	12-7/8	3-1/2	16-1/8	13-7/8	4-1/8	1-5/16	36	19	1-1/4	1	54	26-1/4	21-3/4
060	24-1/8	54-1/8	21	19-1/8	1-1/4	4-7/16	1-1/4	1"	17-3/8	14-7/8	12-7/8	1-1/2	18-1/8	13-7/8	4-1/8	1-5/16	36	19	1-1/4	1	54	26-1/4	21-3/4

## PHYSICAL DATA

MODEL-SIZE	WSHC							WSHX								
		018	024	030	036	042	048		060	018	024	030	036	042	048	060
Compressor (1 Each)	1 Each															
Refrigerant Type	R410A						R410A									
Factory Charge	(LBS.OZ)	3.31	2.78	3.19	4	4.5	4.5	4.5	3.31	2.78	3.19	4	4.5	4.5	4.5	
Motor	Type							Type								
	Speeds							Speeds								
	HP	1/8	1/6	1/2	1/2	1/2	1/2	3/4	HP	1/8	1/6	1/2	1/2	1/2	1/2	3/4
Blower Wheel (Dia x W)	Size	9x7	9x7	9x7	9x8	9x8	10x10	10x10	Size	9x7	9x7	9x7	9x8	9x8	10x10	10x10
Water connection	(FPT)	3/4			1			(FPT)	3/4			1				
Condensate connection	(FPT)							FPT								
Standard TA Filter 1"	Size/Qty	12x16 (2)	12x17 (2)	14x19 (2)	19x19 (2)			Size/Qty	12x16 (2)	12x17 (2)	14x19 (2)	19x19 (2)				
Operating Weight	Contact Factory															
Shipping Weight																

## Blower Performance

PSC Motor and ECM Motor

## BLOWER DATA @ 230V

PSC MOTOR		CFM vs EXTERNAL STATIC PRESSURE (Inches of Water)					COOLING		HTG
MODEL WSHC	FAN SPEED	0.1	0.2	0.3	0.4	0.5	1-10 MINS	10+ MINS	
018	HIGH	820	770	730	640	540			
	MED	710	670	620	530	460		X	X
	LOW	580	540	480	410	---	X		
024	HIGH	1030	980	920	850	750			X
	MED	900	870	830	780	680			
	LOW	730	720	700	650	---	X		
030	MED-HIGH	1100	1040	960	890	800			
	MED-LOW	1060	990	920	850	750		X	X
	LOW	1000	950	880	810	---	X		
036	HIGH	1440	1370	1280	1200	1110			
	MED-HIGH	1360	1300	1240	1160	1080		X	X
	MED-LOW	1250	1200	1150	1080	---	X		
042	HIGH	1390	1320	1250	1200	1070			
	MED-HIGH	1340	1270	1210	1130	1040		X	X
	MED-LOW	1250	1200	1140	1070	---	X		
048	HIGH	1930	1890	1850	1800	1730			
	MED	1790	1770	1740	1690	1630		X	X
	LOW	1640	1630	1620	1590	---	X		
060	HIGH	2310	2240	2170	2100	2020			
	MED	2100	2070	2020	1960	1880		X	X
	LOW	1760	1750	1720	1690	---	X		

ECM MOTOR			CFM vs EXTERNAL STATIC PRESSURE (Inches of Water)				
MODEL WSHX	FAN	TAP	0.1	0.2	0.3	0.4	0.5
		NO.					
018	HIGH STATIC	4	---	---	760	730	680
	HIGH	3	690	640	610	550	510
	LOW	2	600	570	510	470	---
024	HIGH STATIC	4	---	---	820	790	750
	HIGH	3	790	750	720	670	630
	LOW	2	660	610	570	510	460
030	HIGH STATIC	4	---	1070	1020	950	850
	HIGH	3	960	930	900	860	810
	LOW	2	780	750	710	680	630
036	HIGH STATIC	4	---	---	1240	1200	1140
	HIGH	3	1170	1150	1120	1090	1060
	LOW	2	1000	970	950	910	880
042	HIGH STATIC	4	1370	1310	1250	1180	1100
	HIGH	3	1270	1240	1200	1140	1070
	LOW	2	1110	1080	1050	1010	990
048	HIGH STATIC	4	---	---	1810	1770	1730
	HIGH	3	1690	1650	1620	1570	1510
	LOW	2	1350	1310	1250	1200	1170
060	HIGH STATIC	4	---	---	2120	2070	2020
	HIGH	3	2030	2000	1960	1920	1900
	LOW	2	1740	1690	1650	1610	1580

Factory wired for speed taps 1,2 and 3

In keeping with its policy of continuous progress and product improvement, First Co. reserves the right to make changes without notice. Maintenance for all First Co. products is available under "Product Maintenance" at [www.firstco.com](http://www.firstco.com).

## Electrical Data

PSC MOTOR							
WSHC MODEL	VOLTAGE	COMPRESSOR		BLOWER		MCA	MOCP
		RLA	LRA	FLA	HP		
018	208/230V-1-60	7.1	4.3	0.9	1/8	10	15
024	208/230V-1-60	12.8	5.8	1.6	1/6	18	30
030	208/230V-1-60	14.1	7.3	3.1	1/2	22	35
036	208/230V-1-60	16.6	7.9	3.1	1/2	25	40
042	208/230V-1-60	17.9	11.2	3.1	1/2	26	40
048	208/230V-1-60	21.8	11.7	3.5	1/2	31	50
060	208/230V-1-60	26.4	13.4	5.7	3/4	39	60

ECM MOTOR							
WSHX MODEL	VOLTAGE	COMPRESSOR		BLOWER		MCA	MOCP
		RLA	LRA	FLA	HP		
018	208/230V-1-60	7.1	4.3	2.8	1/3	12	15
024	208/230V-1-60	12.8	5.8	2.8	1/3	19	30
030	208/230V-1-60	14.1	7.3	2.8	1/3	20	30
036	208/230V-1-60	16.6	7.9	4.1	1/2	25	40
042	208/230V-1-60	17.9	11.2	6.0	3/4	29	45
048	208/230V-1-60	21.8	11.7	6.0	3/4	33	50
060	208/230V-1-60	26.4	13.4	7.6	1	41	60

# PERFORMANCE DATA @208V

PSC MOTOR			AHRI / ISO 13256-1				STANDARD OPERATING CONDITIONS			
MODEL	CFM	GPM	WATER LOOP (Entering Water Temperature)							
			86 DEG. F		68 DEG. F		85 DEG. F		70 DEG. F	
			CLG	EER	HTG	COP	CLG	EER	HTG	COP
WSHC018	660	6.1	17.4	13.00	22.7	4.20	17.5	13.10	22.9	4.20
WSHC024	780	6.6	23.0	13.00	30.5	4.20	23.1	13.10	30.8	4.20
WSHC030	920	8.8	27.6	13.00	36.4	4.20	27.8	13.20	36.7	4.20
WSHC036	1160	10.5	33.4	13.00	45.0	4.20	33.8	13.20	45.4	4.20
WSHC042	1320	11.6	39.0	13.00	50.0	4.20	39.5	13.10	50.6	4.20
WSHC048	1525	14.0	46.8	13.00	58.1	4.20	47.3	13.10	58.8	4.20
WSHC060	1850	15.5	59.0	13.00	68.1	4.20	59.6	13.20	68.7	4.20

**AHRI/ISO 13256-1 conditions;**

Cooling: Entering air = 80.6 DB / 66.2 WB (F)  
 Entering fluid temperature = 86 (F)

Heating: Entering air = 70 DB (F)  
 Entering fluid temperature = 68 (F)

DATA AT 208V

ECM MOTOR			AHRI / ISO 13256-1				STANDARD OPERATING CONDITIONS			
MODEL	CFM	GPM	WATER LOOP (Entering Water Temperature)							
			86 DEG. F		68 DEG. F		85 DEG. F		70 DEG. F	
			CLG	EER	HTG	COP	CLG	EER	HTG	COP
WSHX018	560	6.1	17.0	14.0	22.0	4.30	17.1	14.10	22.2	4.40
WSHX024	780	6.6	23.2	14.0	30.5	4.40	23.4	14.20	30.8	4.50
WSHX030	900	8.8	27.8	14.0	36.2	4.40	28.0	14.20	36.5	4.50
WSHX036	1150	10.5	33.5	14.0	44.6	4.45	33.9	14.20	45.0	4.60
WSHX042	1270	11.6	39.5	14.0	49.2	4.40	40.0	14.20	50.6	4.50
WSHX048	1575	14.0	47.2	14.0	58.1	4.40	47.7	14.20	58.7	4.50
WSHX060	2000	15.5	60.5	14.0	63.5	4.35	61.1	14.20	64.2	4.50

**Standard operating conditions;**

Cooling: Entering air = 80 DB / 67 WB (F)  
 Entering fluid temperature = 85 (F)

Heating: Entering air = 70 DB (F)  
 Entering fluid temperature = 70 (F)

DATA AT 208V

# HOSE KITS

## Kit #1 3/4" STANDARD FLOW

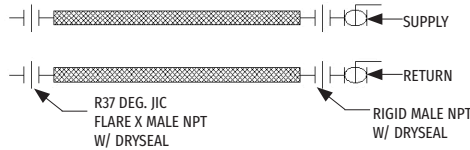
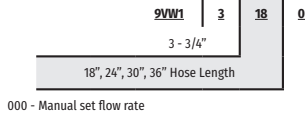

SUPPLY AND RETURN BOTH HAVE 60C WOG BRASS BODIED BALL VALVES WITH ONE TEST PORT ON EACH VALVE AND MEMORY STOPS ON EACH END. ASSEMBLIES ARE MALE PIPE BY MALE PIPE SWIVEL ADAPTER. WORKING PRESSURE/BURST PRESSURE 400/1600 PSI FOR 3/4" HOSE AND 500/2000 PSI FOR 1" HOSE. ALL ASSEMBLIES ARE UL-94VO RATED FOR FLAME RETARDANCY.

## Kit #2 3/4" STANDARD FLOW

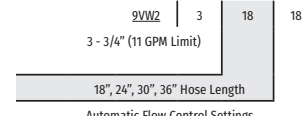

CODE	018	020	025	030	035	040
GPM	1.75	2	2.5	3	0.35	4
CODE	045	050	055	060	065	070
GPM	4.5	5	5.5	6	6.5	7
CODE	075	080	090	100	110	
GPM	7.5	8	9	10	11	

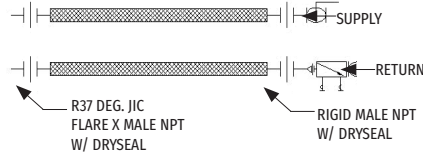

SUPPLY IS BRASS BODIED BALL VALVE WITH ONE TEST PORT. RETURN IS BALL VALVE AND AUTOMATIC CIRCUIT SETTER COMBINATION WITH TWO TEST PORTS. BOTH HOSES ARE MALE PIPE BY MALE PIPE SWIVEL ADAPTER. WORKING PRESSURE/BURST PRESSURE 400/1600 PSI FOR 3/4" HOSE AND 500/2000 PSI FOR 1" HOSE ALL ASSEMBLIES ARE UL-94VO RATED FOR FLAME RETARDANCY.

## Kit #2A 1" HIGH FLOW

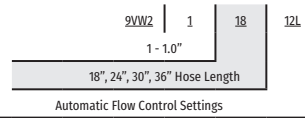

CODE	120	130	140	150	160	
GPM	12	13	14	15	16	

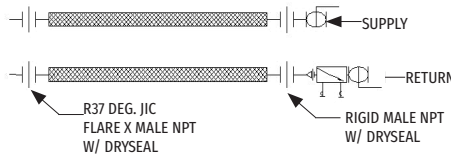

SUPPLY IS BRASS BODIED BALL VALVE WITH ONE TEST PORT. RETURN IS BALL VALVE AND AUTOMATIC CIRCUIT SETTER COMBINATION WITH TWO TEST PORTS. BOTH HOSES ARE MALE PIPE BY MALE PIPE SWIVEL ADAPTER. WORKING PRESSURE/BURST PRESSURE 400/1600 PSI FOR 3/4" HOSE AND 500/2000 PSI FOR 1" HOSE ALL ASSEMBLIES ARE UL-94VO RATED FOR FLAME RETARDANCY.

## Kit #3 3/4" STANDARD FLOW

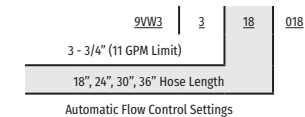

CODE	018	020	025	030	035	040
GPM	1.75	2	2.5	3	0.35	4
CODE	045	050	055	060	065	070
GPM	4.5	5	5.5	6	6.5	7
CODE	075	080	090	100	110	
GPM	7.5	8	9	10	11	

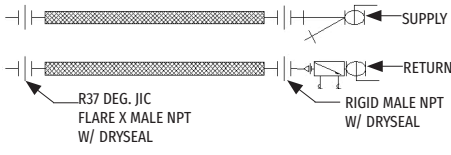

SUPPLY IS A COMBINATION Y-STRAINER/SHUT OFF. ONE TEST PORT AND DRAIN (BLOW DOWN) VALVE. RETURN IS BALL VALVE AND AUTOMATIC CIRCUIT SETTER COMBINATION WITH TWO TEST PORTS. BOTH HOSES ARE MALE BY MALE PIPE SWIVEL ADAPTOR. WORKING PRESURE/BURST PRESSURE 400/1600 PSI FOR 3/4" HOSE AND 500/2000 PSI FOR 1" HOSE. ALL ASSEMBLIES ARE UL-94OVO RATED FOR FLAME RETARDANCY.

## Kit #3A 1" HIGH FLOW

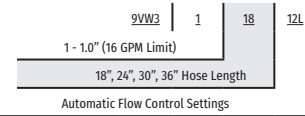

CODE	120	130	140	150	160	
GPM	12	13	14	15	16	

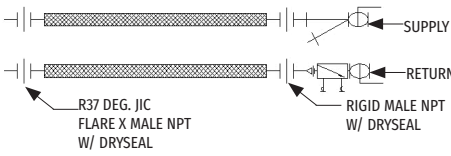

SUPPLY IS A COMBINATION Y-STRAINER/SHUT OFF. ONE TEST PORT AND DRAIN (BLOW DOWN) VALVE. RETURN IS BALL VALVE AND AUTOMATIC CIRCUIT SETTER COMBINATION WITH TWO TEST PORTS. BOTH HOSES ARE MALE BY MALE PIPE SWIVEL ADAPTOR. WORKING PRESURE/BURST PRESSURE 400/1600 PSI FOR 3/4" HOSE AND 500/2000 PSI FOR 1" HOSE. ALL ASSEMBLIES ARE UL-94OVO RATED FOR FLAME RETARDANCY.

## Kit #4 3/4" / 1.0"

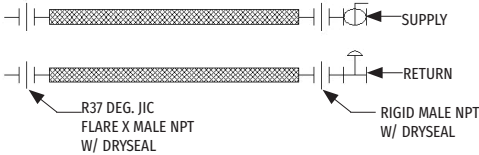
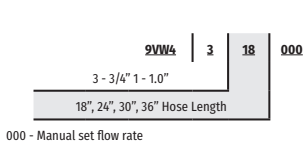

SUPPLY HAS 600 WOG BRASS BODIED BALL VALVE WITH ONE TEST PORT. RETURN HAS MANUAL CIRCUIT SETTER/SHUT OFF VALVE WITH TWO TEST PORTS. ASSEMBLIES ARE MALE PIPE BY MALE PIPE SWIVEL ADAPTER. WORKING PRESSURE/BURST PRESSURE 400/1600 PSI FOR 3/4" HOSE AND 500/2000 PSI FOR 1" HOSE. ALL ASSEMBLIES ARE UL-94OVO RATED FOR FLAME RETARDANCY.

## Kit #5 3/4" / 1.0"

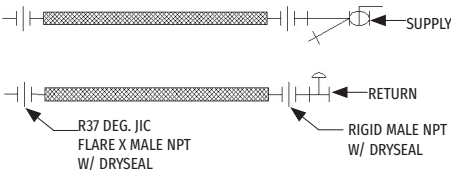
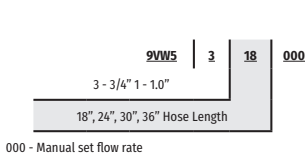

SUPPLY IS A COMBINATION Y-STRAINER/SHUT OFF. ONE TEST PORT AND DRAIN (BLOW DOWN) VALVE. RETURN HAS A MANUAL CIRCUIT SETTER/SHUT OFF VALVE WITH TWO TEST PORTS. BOTH HOSES ARE MALE PIPE BY MALE PIPE SWIVEL ADAPTER. WORKING PRESURE/BURST PRESSURE 400/1600 PSI FOR 3/4" HOSE AND 500/2000 PSI FOR 1" HOSE. ALL ASSEMBLIES ARE UL-94OVO RATED FOR FLAME RETARDANCY.

## Kit #6 3/4" / 1.0"

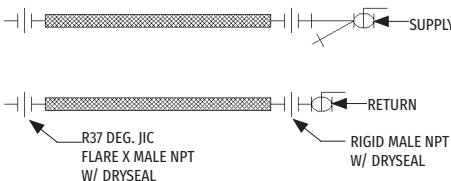
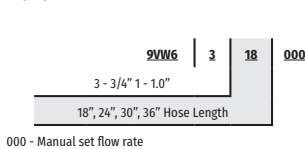

SUPPLY IS A COMBINATION Y-STRAINER/SHUT OFF. ONE TEST PORT AND DRAIN (BLOW DOWN) VALVE. RETURN HAS 600WOG BRASS BODIED BALL VALVE WITH ONE TEST PORT. ASSEMBLIES ARE MALE PIPE BY MALE PIPE SWIVEL ADAPTER. WORKING PRESURE/BURST PRESSURE 400/1600 PSI FOR 3/4" HOSE AND 500/2000 PSI FOR 1" HOSE. ALL ASSEMBLIES ARE UL-94OVO RATED FOR FLAME RETARDANCY.