



# WSH SERIES

*WSHC • WSHX • WSHCE • WSHXE*  
Horizontal Water Source Heat Pump



1/2 thru 5 Tons

R454B



---

# TABLE OF CONTENTS

NOMENCLATURE .....3

SERIES FEATURES .....4

WSHC / WSHX ..... 11

WSHCE / WSHXE ..... 16

HOSE KITS .....21

GUIDE SPECIFICATIONS .....25

First Co.'s customer is ultimately responsible for confirming which fan coil models are compatible with selected outdoor unit(s) and which expansion valves (if any) are required. To determine certified indoor/outdoor combinations, go to [www.firstco.com](http://www.firstco.com) or contact the factory.

In keeping with its policy of continuous progress and product improvement, First Co. reserves the right to make changes without notice.

# NOMENCLATURE

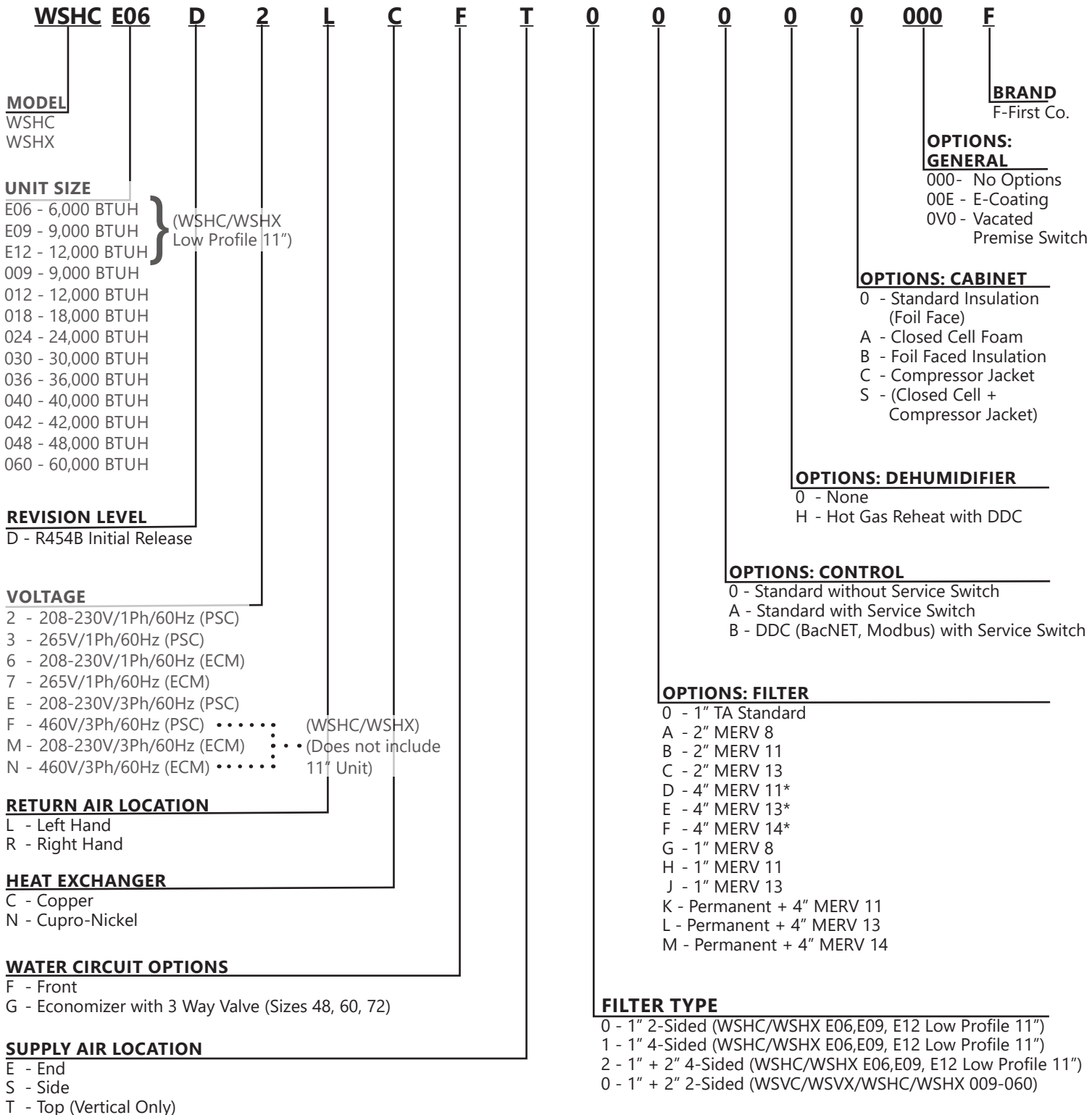

# WSH SERIES

## HORIZONTAL WATER SOURCE HEAT PUMP

### STANDARD FEATURES

- 100% factory run tested
- All units operate with environmentally friendly R-454B refrigerant
- Heavy gauge galvanized steel cabinet
- Cabinets insulated with 3/4" dual density fiberglass insulation treated with an anti-microbial agent
- Non-corrosive thermoplastic condensate pan sloped for positive drainage
- Field convertible discharge air arrangement from end to straight or straight to end
- Large removable panels for service access
- TXV metering device
- High and low pressure service ports
- Refrigerant filter-drier and discharge muffler
- Coaxial water-to-refrigerant heat exchanger
- Heat exchanger available in copper or cupronickel
- Digital Control Module (DCM)
- Multi-speed blower motor
- Panel-mounted FPT Water Connections
- High efficiency rotary compressor
- System reversing valve (4-way )
- Factory mounted hanger brackets
- 50 VA Transformer
- 1" throwaway filter
- 208-230/1/60
- See-through sight glass for troubleshooting without removing the panels

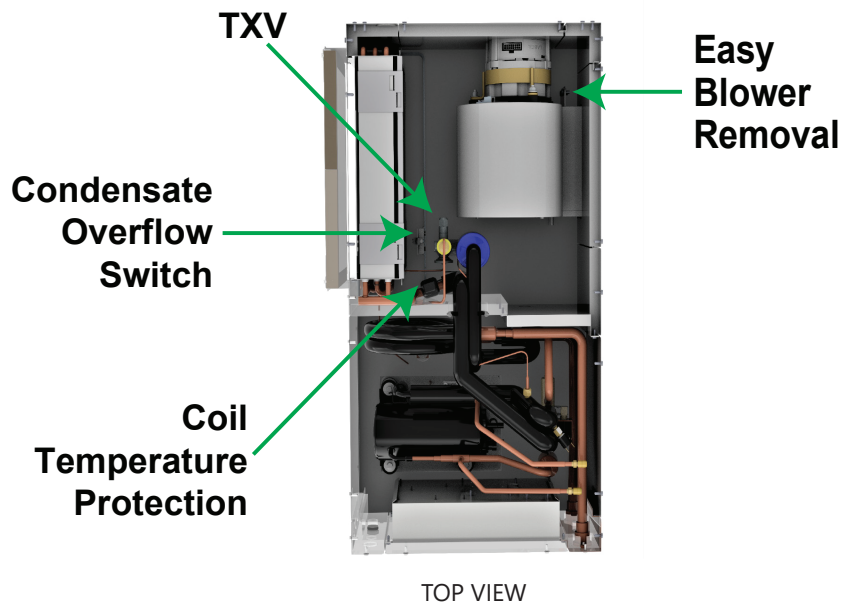

# WSH SERIES

## HORIZONTAL WATER SOURCE HEAT PUMP

### STANDARD FEATURES (CONT.)

#### UNIT CABINET

Fabricated from a minimum of 18 gauge galvanized steel with a durable baked-on powder coat finish. Post and panel construction allows for large access panels to permit full access to internal components. The structural integrity of the cabinets remain unaffected by the removal of any or all access panels.

#### CABINET INSULATION

The cabinets are insulated with 3/4" dual density fiberglass insulation, which offers greater sound absorption and better thermal efficiency. The insulation has a special acrylic coating formulated with an EPA registered anti-microbial agent.

#### EVAPORATIVE COILS, R-454B REFRIGERANT WITH TXV METERING DEVICE

3/8" inch staggered tube type construction with seamless copper tubes and high performance aluminum fins with straight edges. Fins are manufactured with full depth collars, drawn in the fin stock to provide accurate control of fin spacing and completely cover the copper tubes to lengthen coil life. The tubes are mechanically expanded into the fins for a permanent primary to secondary surface bond, assuring maximum heat transfer efficiency. Coil includes moisture carryover diffuser.

#### COAXIAL HEAT EXCHANGER

Features a tube in tube coaxial water-to-refrigerant heat exchanger constructed of a convoluted copper (optional cupronickel) inner tube and steel outer tube with a designed refrigerant working pressure of 600 PSIG (4100 kPa) and designed water side working pressure up to 400 PSIG (2750 kPa).

#### FPT WATER CONNECTION

Panel-mounted female pipe thread- No back-up wrench needed.

#### SERVICE PORT

High side and low side service ports.

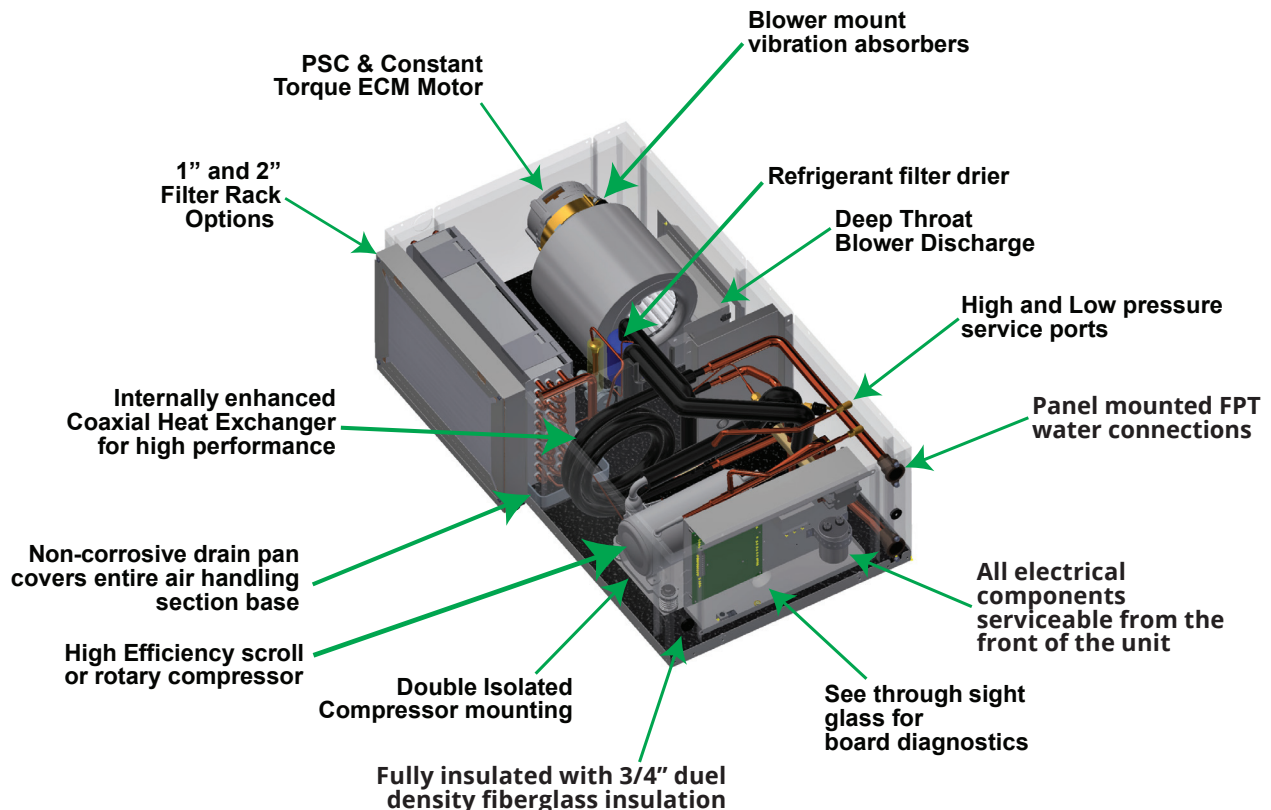

# WSH SERIES

## HORIZONTAL WATER SOURCE HEAT PUMP

### STANDARD FEATURES (CONT.)

#### DRAIN PAN

Made from an UL94-5V rated, rigid PVC **Non-corrosive** material with a three-way slope for positive drainage.

#### BLOWER ASSEMBLIES

Wheels are double width, double inlet (**DWDI**), forward curved, centrifugal type. They are statically and dynamically balanced for a smooth, quiet operation. The Class I housing is constructed of heavy gauge steel with die-formed inlet cones.

#### MOTORS

Constant torque multi-speed, 230V, single phase, 60-Hz or permanent split capacitor (PSC) type, are factory mounted to the blower assembly with rubber isolators.

#### COMPRESSOR

Unit contains a high efficiency rotary compressor. External vibration isolation is provided by rubber mounting devices located underneath the mounting base of the compressor. Internal thermal overload protection is provided. Protection against excessive discharge pressure is provided by means of a high pressure switch. Loss of charge protection is provided by a low pressure safety.

#### REVERSING VALVE

A system reversing valve (4-way valve) is included with all heating/cooling units. This valve is piped to be energized in the cooling mode to allow the system to provide heat if valve failure were to occur. Once the valve is energized for cooling, it will remain energized until the control system is turned to the OFF position, or a heating cycle is initiated. Units with the cooling only option will not receive a reversing valve.

#### DISCHARGE ARRANGEMENT

Field convertible discharge air arrangement from end to straight or straight to end.

#### FILTER SECTION

Includes 1" disposable type fiberglass filters.

#### DIGITAL CONTROL MODULE (DCM)

Controls unit operation and monitors all safety controls. (Patent Pending)

#### REFRIGERANT CIRCUIT

Features a filter-drier and a discharge muffler for quiet operation.

#### 50 VA TRANSFORMER

Assists in accommodating accessory loads.



Drain pan

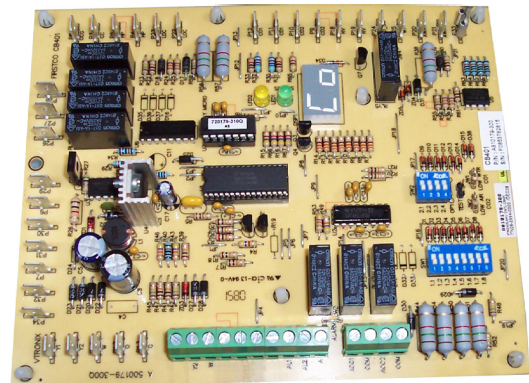

Digital Control Module (DCM)

---

# WSH SERIES

## HORIZONTAL WATER SOURCE HEAT PUMP

### STANDARD FEATURES (CONT.)

#### 100% FACTORY PERFORMED RUN TEST

Every unit is run test prior to packaging.

#### FIELD SELECTABLE SETTINGS:

- 5 Second Compressor Delay-Blower starts before the compressor; attenuates compressor start up sound.
- 45 Second Blower-off Delay-Increases cooling efficiency.
- Dehumidification Mode-Selects low speed fan operation for increased humidity removal.
- VPC Switch-Selects either one or two hour daily operation. (Requires Optional Kit)
- Low water temperature-and low coil temperature cutout options-Optional 10 degree F. cutouts for applications where water temperature is below 50 degrees F. (requires antifreeze solution).
- Accessory Relays (2)-Relays can be selected to cycle with either the fan or compressor. Relay "1" can be configured for use with slow opening water valves (60 second pre-compressor initialization) and relay "2" can be configured for a 30 second post fan delay.

### OPTIONS

#### VACATED PREMISES CONTROL (VPC) WITH RESET FEATURE

Ensures the unit will operate a minimum of one or two hours per day during extended periods of non-occupancy. This option also includes an automatic reset feature. If a fault occurs, the system will shut down, but then automatically reset every 24 hours. If the same fault exists each day, the unit will lockout on the fourth day and have to be manually reset.

#### CUPRO-NICKEL COAXIAL HEAT EXCHANGER

Features a tube in tube coaxial water-to-refrigerant heat exchanger and constructed of a convoluted cupro-nickel inner tube and steel outer tube with a designed refrigerant working pressure of 600 PSIG (4100 kPa) and designed water side working pressure up to 400 PSIG (2750 kPa)

#### E-COAT

Coil will have a flexible epoxy polymer e-coat uniformly applied to all coil surface areas with no material bridging between fins. The coating process will ensure complete coil encapsulation and a uniform dry film thickness from 0.6 – 1.2 mils on all surface areas, including fin edges and meet 5B rating cross-hatch adhesion per ASTM B3359-93.

#### MOTORIZED WATER VALVE

When extreme fluid temperature conditions do not exist with a open loop system, a motorized water valve can be applied to each water-source heat pump. The motorized valve shall stop the flow to the unit, causing pressures to rise. This rise in pressure will halt pump operation to provide greater energy savings of the entire system.

#### PUMP MODULE

The pump module can be a complete self contained pumping package for an earth coupled heat pump system. The module can consist of a single bronze pump, and a brass 3-way shut-off valve. These kits can contain the necessary components for the installation, operation, and maintenance of water circuit of a closed-loop distributed pumping application.

#### HOSES

Hoses need to consist of stainless steel outer braid with an inner core of tube made of a nontoxic synthetic polymer material. The hoses shall be suitable for water temperatures ranging between 33°F and 211°F without the use of glycol.



# WSH SERIES

## HORIZONTAL WATER SOURCE HEAT PUMP

### OPTIONS (CONT'D)

#### BALL VALVE

Ball Valves can be field installed between the unit and the supply and return lines of the loop to stop water flow to the unit in a maintenance or service situation.

#### AUTOMATIC FLOW DEVICES

The automatic flow kit can contain a Hays Mesurflo® automatic flow control valve, two ball valves, two flexible hoses, a high flow strainer, and may include a strainer blow-down and various other accessories. The automatic flow control valve needs to be factory set to a rated flow, and shall automatically control the flow to within 10% of the rated value over 40 to 1 differential pressure, operating range (2 to 80 PSID). Operational temperatures should be rated from fluid 32°F to 225°F. The valve body is constructed from hot forged brass UNS C37700 per ASTM B-283 latest revision.

#### ELECTRIC HEAT 208-230/1/60

Discharge mounted electric heat available with various KW's and options.

#### SPRING ISOLATORS

Kits are available by unit size.

#### VACATED PREMISES CONTROL (VPC) WITH RESET FEATURE

Ensures the unit will operate a minimum of one or two hours per day during extended periods of non-occupancy. This option also includes an automatic reset feature. If a fault occurs, the system will shut down, but then automatically reset every 24 hours. If the same fault exists each day, the unit will lockout on the fourth day and have to be manually reset.

#### CUPRONICKEL COAXIAL HEAT EXCHANGER

Features a tube-in-tube coaxial water-to-refrigerant heat exchanger and constructed of a convoluted cupronickel inner tube and Steel outer tube with a designed refrigerant working pressure of 450 PSIG (3100 kPa) and designed water side working pressure of no less than 400 PSIG (2750 kPa).

E-Coat-Coil will have a flexible epoxy polymer e-coat uniformly applied to all coil surface areas with no material bridging between fins. The coating process will ensure complete coil encapsulation and a uniform dry film thickness from 0.6 – 1.2 mils on all surface areas, including fin edges, and meet 5B rating cross-hatch adhesion per ASTM B3359-93.

#### EVAPORATOR TEMPERATURE SENSOR (ETS)

Prevents freezing evaporator during low ambient conditions.



**VPC**

Vacated Premises Control Option



**Model**

WSHC / WSHX



# WSH SERIES

## HORIZONTAL WATER SOURCE HEAT PUMP

### PHYSICAL DATA

#### ELECTRICAL AND PIPING LOCATIONS

SIZE	CONDENSATE 3/4" FPT	
	AA	BB
009	3	1-1/8
012	3	1-1/8
018	3-3/8	1-1/8
024	3-3/8	1-1/8
030	3-3/8	1-1/8
036	3-3/8	1-1/8
042	3-3/8	1-1/8
048	3-3/8	1-1/8
060	3-3/8	1-1/8

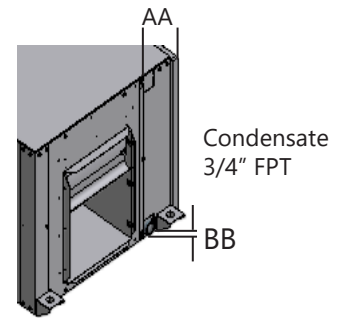
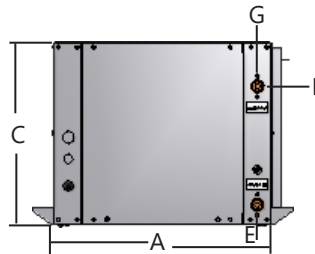
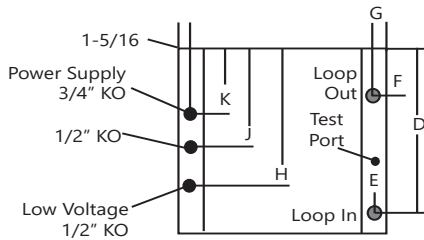

FRONT VIEW

END VIEW

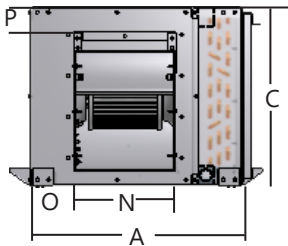

LEFT RETURN /  
END DISCHARGE

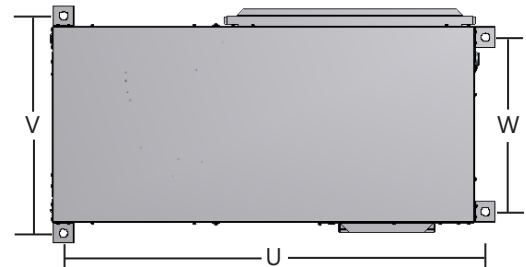

TOP VIEW  
MOUNTING LOCATIONS

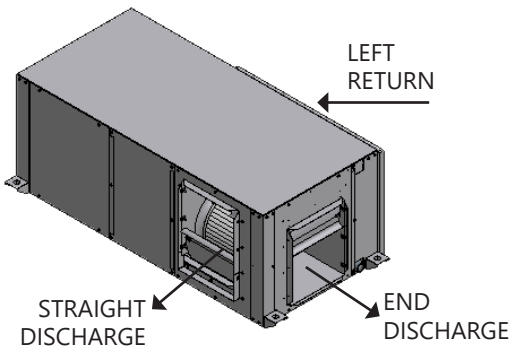

LEFT RETURN / END DISCHARGE

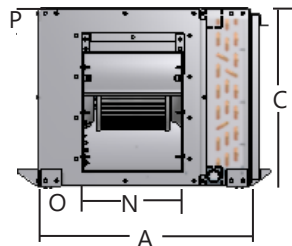

LEFT RETURN /  
END DISCHARGE

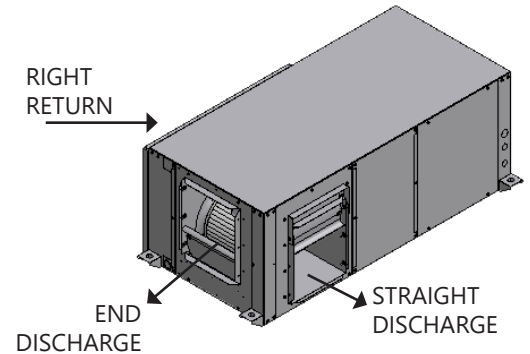

RIGHT RETURN / END DISCHARGE

**MUST SELECT EITHER END DISCHARGE OR STRAIGHT DISCHARGE**

# WSH SERIES

## HORIZONTAL WATER SOURCE HEAT PUMP

### PHYSICAL DATA (CONT'D) ELECTRICAL AND PIPING LOCATIONS

SIZE	OVERALL CABINET			CONNECTIONS				LOOP IN/OUT	ELECTRIC KNOCKOUT			DISCHARGE DUCT FLANGE					RETURN DUCT FLANGE				MNTG. BRACKET CENTER DISTANCES		
	W	L	H	LOOP IN		LOOP OUT			FPT	LOW VOLTAGE		LINE	L	M	N	O	P	Q	R	S	T	U	V
	A	B	C	D	E	F	G	H 1/2"		J 1/2"	K 3/4"												
009	19-1/8	34-1/8	17	15-1/8	1-1/4	3-5/8	1-1/4	3/4"	13-3/8	10-7/8	8-7/8	3-5/8	12	10	5-1/8	3-9/16	14	14	4-3/16	1-1/2	34	21-1/4	16-7/8
012	19-1/8	34-1/8	17	15-1/8	1-1/4	3-5/8	1-1/4	3/4"	13-3/8	10-7/8	8-7/8	3-5/8	12	10	5-1/8	3-9/16	14	14	4-3/16	1-1/2	34	21-1/4	16-7/8
018	20-1/8	43-1/8	17	15-1/8	1-1/4	4-1/8	1-1/4	3/4"	13-3/8	10-7/8	8-7/8	2-5/16	13-5/16	9-7/8	4-1/8	1-5/16	23	15	1-1/4	1	43	22-1/4	17-3/4
024	20-1/8	43-1/8	18-1/4	16-1/2	1-1/4	4-7/16	1-1/4	3/4"	14-5/8	12-1/8	10-1/8	3-5/8	13-5/16	9-7/8	4-3/16	1-5/16	23	16-1/4	1-1/4	1	43	22-1/4	17-3/4
030	20-1/8	43-1/8	18-1/4	16-1/2	1-1/4	3-1/8	1-1/4	3/4"	14-5/8	12-1/8	10-1/8	3-5/8	13-5/16	9-7/8	4-3/16	1-5/16	23	19	1-1/4	1	43	22-1/4	17-3/4
036	20-1/8	47-1/8	21	19-1/8	1-1/4	5-3/4	1-1/4	3/4"	17-3/8	14-7/8	12-7/8	2-1/2	16-1/8	10-7/8	3	2-5/16	25-1/2	19	1-1/4	1	47	22-1/4	17-3/4
042	20-1/8	47-1/8	21	19-1/8	1-1/4	4-3/4	1-1/4	3/4"	17-3/8	14-7/8	12-7/8	2-1/2	16-1/8	10-7/8	3	2-5/16	25-1/2	19	1-1/4	1	47	22-1/4	17-3/4
048	24-1/8	54-1/8	21	19-1/8	1-1/4	4-7/16	1-1/4	1"	17-3/8	14-7/8	12-7/8	3-1/2	16-1/8	13-7/8	4-1/8	1-5/16	36	19	1-1/4	1	54	26-1/4	21-3/4
060	24-1/8	54-1/8	21	19-1/8	1-1/4	4-7/16	1-1/4	1"	17-3/8	14-7/8	12-7/8	1-1/2	18-1/8	13-7/8	4-1/8	1-5/16	36	19	1-1/4	1	54	26-1/4	21-3/4

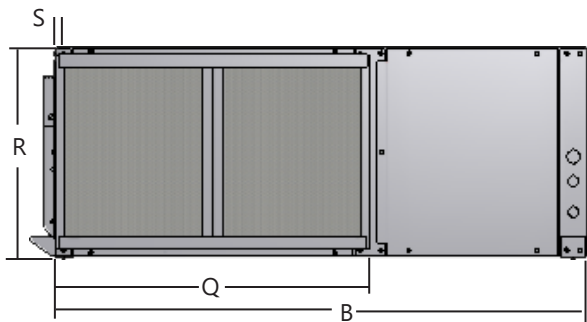

LEFT RETURN / LEFT VIEW

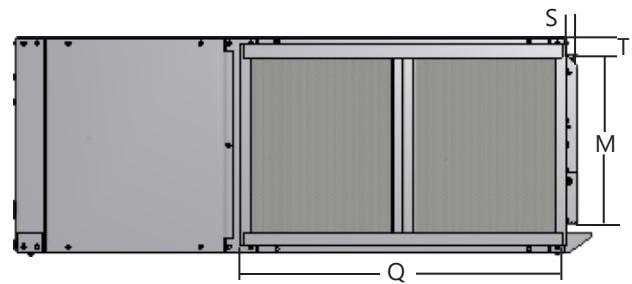

RIGHT RETURN / RIGHT VIEW

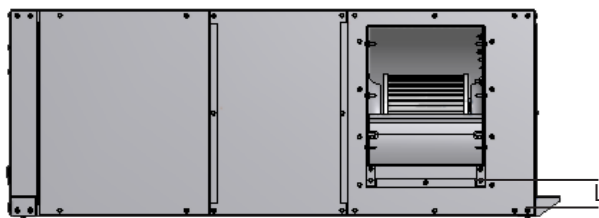

LEFT RETURN / STRAIGHT DISCHARGE

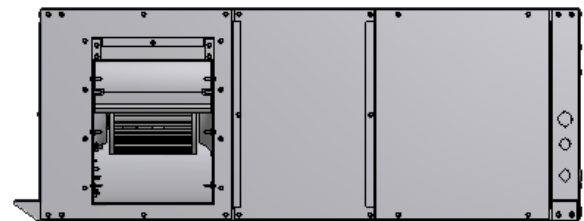

RIGHT RETURN / STRAIGHT DISCHARGE

# WSH SERIES

HORIZONTAL WATER SOURCE HEAT PUMP

# WSHC / WSHX

DATA TABLES

## PHYSICAL DATA

MODEL-SIZE	WSHC										WSHX							
	009	012	018	024	030	036	042	048	060	018	024	030	036	042	048	060		
Compressor (1 Each)	1 EACH																	
Refrigerant Type	R454B										R454B							
Factory Charge	lb [kg]	1.42 [0.64]	1.62 [0.73]	1.9 [0.86]	2.2 [1]	2.6 [1.18]	3.06 [1.39]	3.08 [1.39]	3.98 [1.8]	4.98 [2.26]	lb [kg]	1.9 [0.86]	2.2 [1]	2.6 [1.18]	3.06 [1.39]	3.08 [1.39]	3.98 [1.8]	4.98 [2.26]
Motor	Type	PSC									Type	ECM						
	Speeds	4									Speeds	3						
	HP	1/10	1/10	1/8	1/6	1/2	1/2	1/2	1/2	3/4	HP	1/8	1/6	1/2	1/2	1/2	1/2	3/4
Blower Wheel (Dia x W)	Size	6.75 x 5.50	9x7	9x7	9x7	9x8	9x8	10x10	10x10	Size	9x7	9x7	9x7	9x8	9x8	10x10	10x10	
Water Connection	(FPT)	1/2		3/4				1		(FPT)	3/4				1			
Condensate Connection	(FPT)	1/2		3/4				1		(FPT)	3/4				1			
Standard TA Filter 1"	Size/Qty	10x18 (1)	12x16 (2)	12x17 (2)	14x19 (2)	19x19 (2)	19x19 (2)	Size/Qty	12x16 (2)	12x17 (2)	14x19 (2)	19x19 (2)						
Operating Weight	CONTACT FACTORY																	
Shipping Weight	CONTACT FACTORY																	

## BLOWER PERFORMANCE

### PSC MOTOR

WSHC PSC MOTOR		CFM vs EXTERNAL STATIC PRESSURE (Inches of Water)					COOLING		HEATING
MODEL WSHC	FAN SPEED	0.1	0.2	0.3	0.4	0.5	1-10 MINS	10+ MINS	
009	HIGH	460	400	330	---	---		X	X
	LOW	350	300	230	---	--	X		
012	HIGH	510	500	470	450	420		X	X
	MED	360	350	330	310	290	X		
	LOW	280	260	---	---	---			
018	HIGH	820	770	730	640	540			
	MED	710	670	620	530	460		X	X
	LOW	580	540	480	410	---	X		
024	HIGH	1030	980	920	850	750		X	X
	MED	900	870	830	780	680			
	LOW	730	720	700	650	---	X		
030	MED-HIGH	1100	1040	960	890	800			
	MED-LOW	1060	990	920	850	750		X	X
	LOW	1000	950	880	810	---	X		
036	HIGH	1440	1370	1280	1200	1110			
	MED-HIGH	1360	1300	1240	1160	1080		X	X
	MED-LOW	1250	1200	1150	1080	---	X		
042	HIGH	1390	1320	1250	1200	1070			
	MED-HIGH	1340	1270	1210	1130	1040		X	X
	MED-LOW	1250	1200	1140	1070	---	X		
048	HIGH	1930	1890	1850	1800	1730			
	MED	1790	1770	1740	1690	1630		X	X
	LOW	1640	1630	1620	1590	---	X		
060	HIGH	2310	2240	2170	2100	2020			
	MED	2100	2070	2020	1960	1880		X	X
	LOW	1760	1750	1720	1690	---	X		

### BLOWER PERFORMANCE (CONT'D)

#### ECM MOTOR

WSHX ECM MOTOR			CFM vs EXTERNAL STATIC PRESSURE (Inches of Water)				
MODEL WSHX	FAN	TAP NO.	0.1	0.2	0.3	0.4	0.5
018	HIGH STATIC	4	---	---	760	730	680
	HIGH	3	690	640	610	550	510
	LOW	2	600	570	510	470	---
024	HIGH STATIC	4	---	---	820	790	750
	HIGH	3	790	750	720	670	630
	LOW	2	660	610	570	510	460
030	HIGH STATIC	4	---	1070	1020	950	850
	HIGH	3	960	930	900	860	810
	LOW	2	780	750	710	680	630
036	HIGH STATIC	4	---	---	1240	1200	1140
	HIGH	3	1170	1150	1120	1090	1060
	LOW	2	1000	970	950	910	880
042	HIGH STATIC	4	1370	1310	1250	1180	1100
	HIGH	3	1270	1240	1200	1140	1070
	LOW	2	1110	1080	1050	1010	990
048	HIGH STATIC	4	---	---	1810	1770	1730
	HIGH	3	1690	1650	1620	1570	1510
	LOW	2	1350	1310	1250	1200	1170
060	HIGH STATIC	4	---	---	2120	2070	2020
	HIGH	3	2030	2000	1960	1920	1900
	LOW	2	1740	1690	1650	1610	1580

FACTORY WIRED FOR SPEED TAPS 1, 2 AND 3

### ELECTRICAL DATA

WSHC ELECTRICAL DATA							
Model	Voltage	Compressor		Blower		MCA	MOP
		RLA	LRA	FLA	HP		
WSHC009*	208/230V-1-60	3.97	22	0.6	1/12	6	15
	265V-1-60	3.97	23	0.6	1/12	6	15
WSHC012*	208/230V-1-60	4.7	25	0.7	1/10	7	15
	265V-1-60	3.91	21	0.7	1/10	6	15
WSHC018*	208/230V-1-60	6.6	36	0.9	1/8	10	15
	265V-1-60	5.45	36	0.9	1/8	8	15
WSHC024*	208/230V-1-60	11.3	63	1.6	1/6	16	30
	265V-1-60	8.09	45	1.4	1/6	12	20
WSHC030*	208/230V-1-60	12.8	71	3.1	1/2	20	35
	265V-1-60	10.4	68	2.7	1/2	16	25
WSHC036*	208/230V-1-60	15.5	86	3.1	1/2	23	40
	265V-1-60	10.26	55	2.7	1/2	16	25
	208/230V-3-60	21.84	70	3.1	1/2	31	50
	460V-3-60	7.1	39	1.6	1/2	11	20
WSHC042*	208/230V-1-60	17.3	96	3.1	1/2	25	40
	208/230V-3-60	23.2	90	3.1	1/2	33	50
	460V-3-60	6.5	36	1.6	1/2	10	15
WSHC048*	208/230V-1-60	19.3	102	3.5	1/2	28	50
	208/230V-3-60	22.1	123	3.5	1/2	32	50
	460V-3-60	10.7	60	1.4	1/2	15	25
WSHC060*	208/230V-1-60	26.6	148	5.7	3/4	39	60
	208/230V-3-60	16.7	93	5.7	3/4	27	40
	460V-3-60	6.6	60	2.4	3/4	11	20

### ELECTRICAL DATA (CONT'D)

WSHX ELECTRICAL DATA							
Model	Voltage	Compressor		Blower		MCA	MOP
		RLA	LRA	FLA	HP		
WSHX018*	208/230V-1-60	6.6	36	2.8	1/3	12	15
	265V-1-60	5.45	36	2.8	1/3	10	15
WSHX024*	208/230V-1-60	11.3	63	2.8	1/3	17	30
	265V-1-60	8.09	45	4.1	1/2	15	25
WSHX030*	208/230V-1-60	12.8	71	4.1	1/2	21	30
	265V-1-60	10.4	68	2.1	1/2	16	25
WSHX036*	208/230V-1-60	15.5	86	4.1	1/2	24	40
	265V-1-60	10.26	55	3.1	1/2	16	30
	208/230V-3-60	21.84	70	4.1	1/2	32	50
	460V-3-60	7.1	39	2.1	1/2	11	20
WSHX042*	208/230V-1-60	17.3	96	4.1	1/2	26	45
	208/230V-3-60	23.2	90	4.1	1/2	34	50
	460V-3-60	6.5	36	3.2	3/4	12	20
WSHX048*	208/230V-1-60	19.3	102	6	3/4	31	50
	208/230V-3-60	22.1	123	6	3/4	34	50
	460V-3-60	10.7	60	3.2	3/4	17	30
WSHX060*	208/230V-1-60	26.6	148	7.6	1	41	60
	208/230V-3-60	16.7	93	7.6	1	29	45
	460V-3-60	6.6	60	4	1	13	20

### PERFORMANCE DATA @208V

WSHC PERFORMANCE DATA - PSC MOTOR										
PSC MOTOR			AHRI / ISO 13256-1				STANDARD OPERATING CONDITIONS			
MODEL	CFM	GPM	WATER LOOP (Entering Water Temperature)				GROUND WATER (Entering Water Temperature)			
			86°F		68°F		85°F		70°F	
			CLG	EER	HTG	COP	CLG	EER	HTG	COP
WSHC009D*	280	3.0	8,000	13.0	11,200	4.3	8,500	19.0	8,100	3.6
WSHC012D*	450	3.5	11,000	13.0	14,000	4.3	13,600	19.0	10,700	3.6
WSHC018D*	630	6.1	17,400	13.0	19,000	4.3	19,500	18.0	15,800	3.6
WSHC024D*	780	6.6	23,000	13.0	26,200	4.3	27,000	18.0	22,400	3.6
WSHC230D*	920	8.8	27,000	13.0	31,000	4.3	28,000	18.0	25,800	3.7
WSHC036D*	1160	10.5	33,400	13.0	44,000	4.3	37,600	18.0	36,000	3.7
WSHC042D*	1320	11.6	39,000	13.0	47,000	4.3	43,000	18.0	38,500	3.7
WSHC048D*	1525	14.0	48,000	13.0	50,000	4.3	54,000	19.0	43,000	3.6
WSHC060D*	1850	15.5	59,000	13.0	68,000	4.3	64,000	18.8	55,000	3.6

**AHRI/ISO 13256-1 conditions;**

Cooling: Entering air = 80.6 DB / 66.2 WB (F)  
 Entering fluid temperature = 86°F

Heating: Entering air = 70 DB (F)  
 Entering fluid temperature = 68°F

**DATA AT 208V**

WSHX PERFORMANCE DATA - ECM MOTOR										
ECM MOTOR			AHRI / ISO 13256-1				STANDARD OPERATING CONDITIONS			
MODEL	CFM	GPM	WATER LOOP (Entering Water Temperature)				GROUND WATER (Entering Water Temperature)			
			86°F		68°F		85°F		70°F	
			CLG	EER	HTG	COP	CLG	EER	HTG	COP
WSHX018D*	560	6.1	17,000	14.0	18,000	4.3	19,000	19.8	16,000	3.6
WSHX024D*	780	6.6	23,000	14.0	30,000	4.4	28,000	19.8	24,600	3.8
WSHX030D*	900	8.8	27,800	14.0	30,800	4.4	31,000	19.6	26,000	3.8
WSHX036D*	1150	10.5	33,400	14.0	43,500	4.4	38,500	19.8	35,000	3.8
WSHX042D*	1270	11.6	39,500	14.0	46,000	4.4	49,000	19.6	39,000	3.8
WSHX048D*	1575	14	48,500	14.0	58,000	4.4	54,500	19.8	43,000	3.6
WSHX060D*	2000	15.5	60,000	13.0	64,000	4.3	66,000	19.7	56,500	3.8

**Standard Operating Conditions;**

Cooling: Entering air = 80.6 DB / 66.2 WB (F)  
 Entering fluid temperature = 86°F

Heating: Entering air = 70 DB (F)  
 Entering fluid temperature = 68°F

**DATA AT 208V**



# WSH SERIES

HORIZONTAL WATER SOURCE HEAT PUMP

# WSHCE / WSHXE

DATA TABLES

## PHYSICAL DATA

MODEL-SIZE	WSHCE	PSC MOTOR		
		006	09	012
Compressor (1 Each)	1 Each	Rotary		
Refrigerant Type	R-454B			
Factory Charge	lb [kg]	1.24 [0.56]	1.3 [0.59]	1.38 [0.63]
A2L Sensor and Mitigation YES/NO		NO	NO	NO
Minimum Room Area Ft <sup>2</sup> [m <sup>2</sup> ]		N/A	N/A	N/A
Minimum Air Flow CFM (m <sup>3</sup> /hr)		N/A	N/A	N/A
Motor	Type	PSC		
	Speeds	3		
	HP [kw]	1/8 [.09]		1/5 [.15]
Blower Wheel (Dia x W)	Size in.	5.25 x 6.00		
Water connection	(FPT) in.	3/4		
COAX Volume	(US Gallons)	0.083	0.116	0.116
Condensate connection	(FPT) in.	3/4		
Standard TA Filter 1"	Size in. [cm]	(1) 10x16x1 [25.4 x 38.1x 2.54]		
Operating Weight	lbs [kg]	108 [49]	110 [50]	110 [50]
Shipping Weight	lbs [kg]	123 [56]	125 [57]	125 [57]

MODEL-SIZE	WSHXE	ECM MOTOR		
		006	009	012
Compressor (1 Each)	1 Each	Rotary		
Refrigerant Type	R-454B			
Factory Charge	lb [kg]	1.24 [0.56]	1.3 [0.59]	1.38 [0.63]
A2L Sensor and Mitigation YES/NO		NO	NO	NO
Minimum Room Area Ft <sup>2</sup> [m <sup>2</sup> ]		N/A	N/A	N/A
Minimum Air Flow CFM (m <sup>3</sup> /hr)		N/A	N/A	N/A
Motor	Type	ECM		
	Speeds	Multiple		
	HP [kw]	1/4 [.18]		
Blower Wheel (Dia x W)	Size in.	5.25 x 6.00		6 x 5
Water connection	(FPT) in.	3/4		
COAX Volume	(US Gallons)	0.083	0.116	0.116
Condensate connection	(FPT) in.	3/4		
Standard TA Filter 1"	Size in. [cm]	(1) 10x16x1 [25.4 x 38.1x 2.54]		
Operating Weight	lb [kg]	108 [49]	110 [50]	110 [50]
Shipping Weight	lb [kg]	123 [56]	125 [57]	125 [57]

# WSH SERIES

HORIZONTAL WATER SOURCE HEAT PUMP

# WSHCE / WSHXE

DATA TABLES

## PHYSICAL DATA (CONT'D)

WATER PRESSURE DROP						
WSHC,XE06	GPM	1	1.25	1.5	1.75	2
	PSI	0.1	0.4	0.8	1.2	1.6
WSHC,XE09	GPM	1	1.5	2	2.5	3
	PSI	0.6	1	1.6	2.3	3
WSHC,XE12	GPM	2	2.5	3	3.5	4
	PSI	1.3	1.9	2	3.3	3.8
GPM - Flow Rate PSI - Pressure Drop						

# WSH SERIES

HORIZONTAL WATER SOURCE HEAT PUMP

# WSHCE / WSHXE

DATA TABLES

## DIMENSIONS

SIZE	OVERALL CABINET			CONNECTIONS				LOOP IN/OUT	ELECTRIC KNOCKOUT			DISCHARGE DUCT FLANGE					RETURN DUCT FLANGE			
	W	L	H	LOOP IN		LOOP OUT			LOW VOLTAGE		LINE	L	M	N	O	P	Q	R	S	T
	A	B	C	D	E	F	G	FPT	H	J	K									
006	19	36	11	9.2	1.3	2.1	1.3	3/4	7.4	4.4	2.9	0.9	4.3	9.1	4.6	5.8	18.3	10.9	0.6	0.9
009	19	36	11	9.2	1.3	2.1	1.3	3/4	7.4	4.4	2.9	0.9	4.3	9.1	4.6	5.8	18.3	10.9	0.6	0.9
012	19	36	11	9.2	1.3	2.1	1.3	3/4	7.4	4.4	2.9	0.9	4.3	9.1	4.6	5.8	18.3	10.9	0.6	0.9

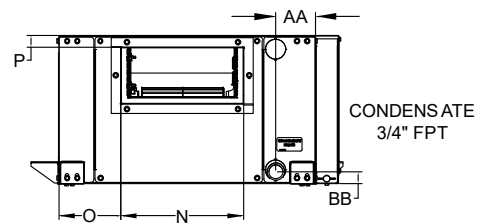
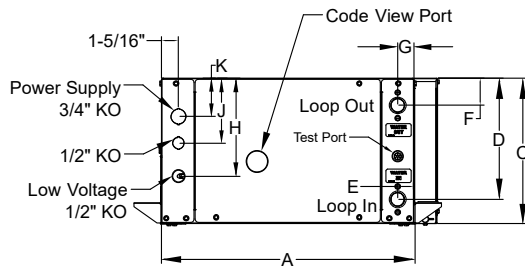
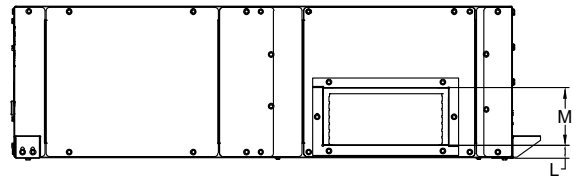
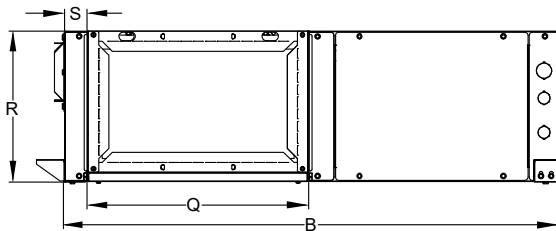
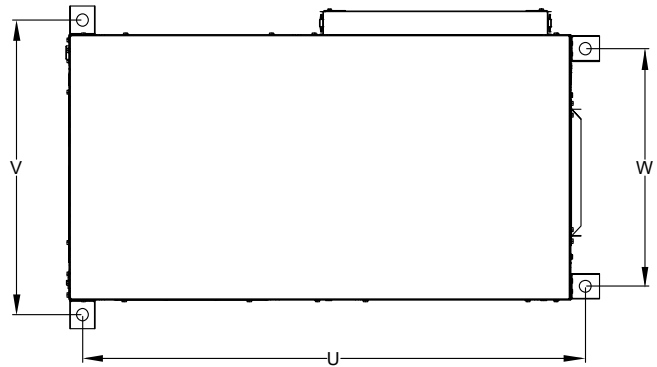
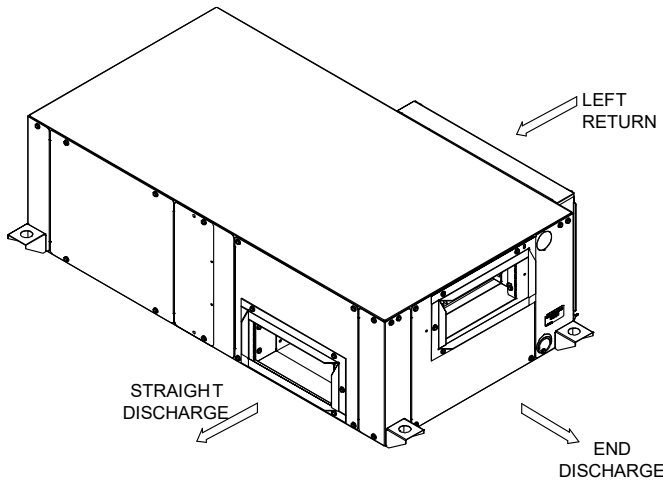

SIZE	U	V	W	CONDENSATE 3/4" FPT		NOMINAL FILTER SIZE
	MOUNTING BRACKET CENTER DISTANCE			AA	BB	
006	34.1	21.3	16.8	3	1-1/8	10X16
009	34.1	21.3	16.8	3	1-1/8	10X16
012	34.1	21.3	16.8	3-3/8	1-1/8	10X16

# WSH SERIES

HORIZONTAL WATER SOURCE HEAT PUMP

# WSHCE / WSHXE

DATA TABLES

## BLOWER DATA

PSC MOTOR													Factory Blower Settings	
Model	Fan Speed	Rated Airflow	CFM VS. Static Pressure (in. w.g)										Cooling	Heating
			0.1	0.2	0.3	0.4	0.5	0.6	0.7	0.8	0.9	1.0		
WSHCE06	High	300	330	300	260	230	200	---	---	---	---	---		
	Medium		320	290	250	220	180	---	---	---	---	---	x	x
	Low		310	280	240	210	170	---	---	---	---	---		
WSHCE09	High	330	330	300	260	230	200	---	---	---	---	---		
	Medium		320	290	250	220	180	---	---	---	---	---	x	x
	Low		310	280	240	210	170	---	---	---	---	---		
WSHCE12	High	450	480	450	420	390	360	330	---	---	---	---		
	Medium		430	400	370	340	310	---	---	---	---	---	x	x
	Low		370	340	320	300	---	---	---	---	---	---		

Airflow data shown is with a dry coil at 70°F DB EAT and with standard 1" filter

ECM MOTOR													Factory Blower Settings		
Model	Fan Speed	Rated Airflow	CFM VS. Static Pressure (in. w.g)										Cooling		Heating
			0.1	0.2	0.3	0.4	0.5	0.6	0.7	0.8	0.9	1.0	1-10 Min	10+ Min	
WSHXE06	T3	300	390	370	340	300	250	230	210	190	---	---			
	T2		310	300	280	270	230	210	190	---	---	---		x	x
	T1		210	190	170	150	---	---	---	---	---	---	x		
WSHXE09	T3	330	420	390	360	320	280	260	230	---	---	---			
	T2		390	370	340	300	250	230	210	---	---	---		x	x
	T1		310	300	280	270	230	210	---	---	---	---	x		
WSHXE12	T3	400	450	420	390	360	320	280	---	---	---	---			
	T2		390	370	340	300	280	---	---	---	---	---		x	x
	T1		360	340	320	290	---	---	---	---	---	---	x		

Airflow data shown is with a dry coil at 70°F DB EAT and with standard 1" filter

# WSH SERIES

HORIZONTAL WATER SOURCE HEAT PUMP

# WSHCE / WSHXE

DATA TABLES

## ELECTRICAL DATA

PSC MOTOR							
Model	Voltage	Compressor		Blower		MCA	MOP
		RLA	LRA	FLA	HP		
WSHCE06	208/230V-1-60	2.9	16	0.65	1/8	5	15
	265V-1-60	1.9	10.7	0.60	1/8	4	15
WSHCE09	208/230V-1-60	4.5	25	0.65	1/8	7	15
	265V-1-60	3.6	20	0.60	1/8	6	15
WSHCE12	208/230V-1-60	5.4	30	1.2	1/5	8	15
	265V-1-60	4.3	24	1.1	1/5	7	15

ECM MOTOR							
Model	Voltage	Compressor		Blower		MCA	MOP
		RLA	LRA	FLA	HP		
WSHXE06	208/230V-1-60	2.9	16	2.3	1/4	6	15
	265V-1-60	1.9	10.7	2.3	1/4	5	15
WSHXE09	208/230V-1-60	4.5	25	2.3	1/4	8	15
	265V-1-60	3.6	20	2.3	1/4	7	15
WSHXE12	208/230V-1-60	5.4	30	2.3	1/4	10	15
	265V-1-60	4.3	24	2.3	1/4	8	15

## PERFORMANCE DATA

Model	V/Ph/Hz	Rated Airflow	GPM	Water Loop (Entering Water Temperature)				Ground Water (Entering Water Temperature)			
				86°F		68°F		59°F		50°F	
				Cooling	EER	Heating	COP	Cooling	EER	Heating	COP
WSHCE06D*	208-230/1/60	300	2.0	6,000	13.4	6,500	4.3	8,000	22.3	5,800	3.8
WSHCE09D*	208-230/1/60	330	2.5	9,400	13.0	13,000	4.3	11,200	21.0	10,000	3.7
WSHCE12D*	208-230/1/60	450	3.0	14,000	12.2	10,000	4.3	12,000	19.5	11,000	3.6

Model	V/Ph/Hz	Rated Airflow	GPM	Water Loop (Entering Water Temperature)				Ground Water (Entering Water Temperature)			
				86°F		68°F		59°F		50°F	
				Cooling	EER	Heating	COP	Cooling	EER	Heating	COP
WSHXE06D*	208-230/1/60	280	2.0	6,000	14.4	6,800	4.4	8,000	23.5	5,800	3.8
WSHXE09D*	208-230/1/60	330	2.5	10,000	13.5	12,000	4.3	11,000	22.0	10,000	3.7
WSHXE12D*	208-230/1/60	630	3.0	11,500	13.0	13,600	4.3	13,500	21.0	11,500	3.8

**Cooling:** Entering air = 80.6 DB / 66.2 WB (F)  
Entering fluid temperature = 86° (F)

**Heating:** Entering air = 70 DB (F)  
Entering fluid temperature = 68° (F)

**DATA AT 208V**

# WSH SERIES

## HORIZONTAL WATER SOURCE HEAT PUMP

### HOSE KITS

#### KIT NUMBER 1 THRU NUMBER 2

KIT #1 3/4" STANDARD FLOW						
				9VW1	3	18
				3 - 3/4"		0
				18", 24", 30", 36" Hose Length		
000 - Manual set flow rate						

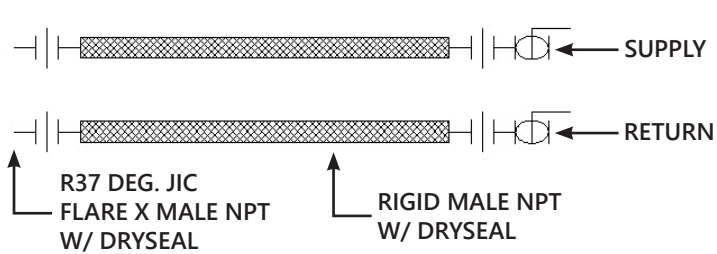

SUPPLY AND RETURN BOTH HAVE 60C WOG BRASS BODIED BALL VALVES WITH ONE TEST PORT ON EACH VALVE AND MEMORY STOPS ON EACH END. ASSEMBLIES ARE MALE PIPE BY MALE PIPE SWIVEL ADAPTER. WORKING PRESSURE/BURST PRESSURE 400/1600 PSI FOR 3/4" HOSE AND 500/2000 PSI FOR 1" HOSE. ALL ASSEMBLIES ARE UL-94VO RATED FOR FLAME RETARDANCY.

KIT #2 3/4" STANDARD FLOW						
				9VW2	3	18
				3 - 3/4" (11 GPM Limit)		18
				18", 24", 30", 36" Hose Length		
				Automatic Flow Control Settings		
CODE	018	020	025	030	035	040
GPM	1.75	2	2.5	3	0.35	4
CODE	045	050	055	060	065	070
GPM	4.5	5	5.5	6	6.5	7
CODE	075	080	090	100	110	
GPM	7.5	8	9	10	11.	

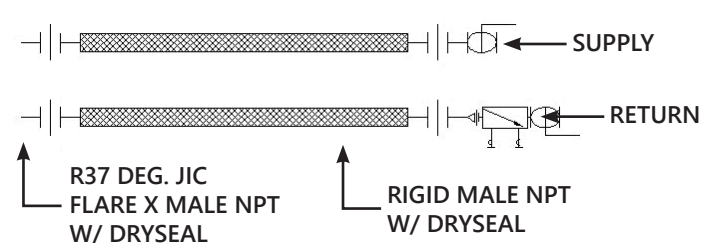

SUPPLY IS BRASS BODIED BALL VALVE WITH ONE TEST PORT. RETURN IS BALL VALVE AND AUTOMATIC CIRCUIT SETTER COMBINATION WITH TWO TEST PORTS. BOTH HOSES ARE MALE PIPE BY MALE PIPE SWIVEL ADAPTER. WORKING PRESSURE/BURST PRESSURE 400/1600 PSI FOR 3/4" HOSE AND 500/2000 PSI FOR 1" HOSE ALL ASSEMBLIES ARE UL-94VO RATED FOR FLAME RETARDANCY.

# WSH SERIES

## HORIZONTAL WATER SOURCE HEAT PUMP

### HOSE KITS (CONT'D)

#### KIT NUMBER 2A THRU NUMBER 3

KIT #2A 1" HIGH FLOW						
			9VW2	1	18	12L
			1 - 1.0"			
			18", 24", 30", 36" Hose Length			
			Automatic Flow Control Settings			
CODE	120	130	140	150	160	
GPM	12	13	14	15	16	

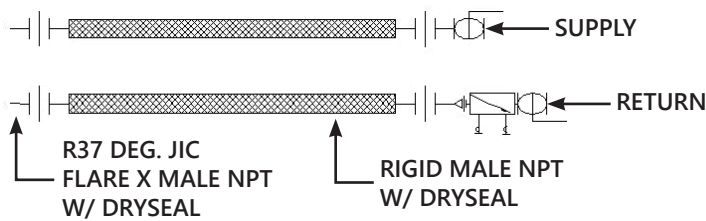

SUPPLY IS BRASS BODIED BALL VALVE WITH ONE TEST PORT. RETURN IS BALL VALVE AND AUTOMATIC CIRCUIT SETTER COMBINATION WITH TWO TEST PORTS. BOTH HOSES ARE MALE PIPE BY MALE PIPE SWIVEL ADAPTER. WORKING PRESSURE/BURST PRESSURE 400/1600 PSI FOR 3/4" HOSE AND 500/2000 PSI FOR 1" HOSE ALL ASSEMBLIES ARE UL-94VO RATED FOR FLAME RETARDANCY.

KIT #3 3/4" STANDARD FLOW						
			9VW3	3	18	018
			3 - 3/4" (11 GPM Limit)			
			18", 24", 30", 36" Hose Length			
			Automatic Flow Control Settings			
CODE	018	020	025	030	035	040
GPM	1.75	2	2.5	3	0.35	4
CODE	045	050	055	060	065	070
GPM	4.5	5	5.5	6	6.5	7
CODE	075	080	090	100	110	
GPM	7.5	8	9	10	11	

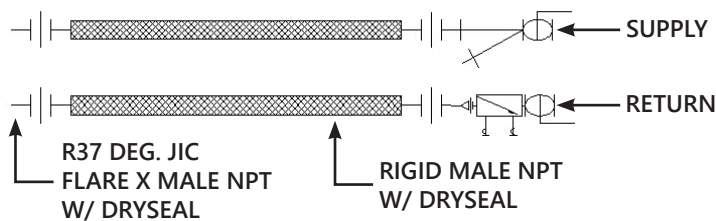

SUPPLY IS A COMBINATION Y-STRAINER/SHUT OFF. ONE TEST PORT AND DRAIN (BLOW DOWN) VALVE. RETURN IS BALL VALVE AND AUTOMATIC CIRCUIT SETTER COMBINATION WITH TWO TEST PORTS. BOTH HOSES ARE MALE PIPE BY MALE PIPE SWIVEL ADAPTOR. WORKING PRESURE/BURST PRESSURE 400/1600 PSI FOR 3/4" HOSE AND 500/2000 PSI FOR 1" HOSE. ALL ASSEMBLIES ARE UL-940VO RATED FOR FLAME RETARDANCY.



# WSH SERIES

## HORIZONTAL WATER SOURCE HEAT PUMP

### HOSE KITS (CONT'D)

#### KIT NUMBER 3A THRU NUMBER 4

KIT #3A 1" HIGH FLOW						
			9VW3	1	18	12L
	1 - 1.0" (16 GPM Limit)					
	18", 24", 30", 36" Hose Length					
	Automatic Flow Control Settings					
CODE	120	130	140	150	160	
GPM	12	13	14	15	16	

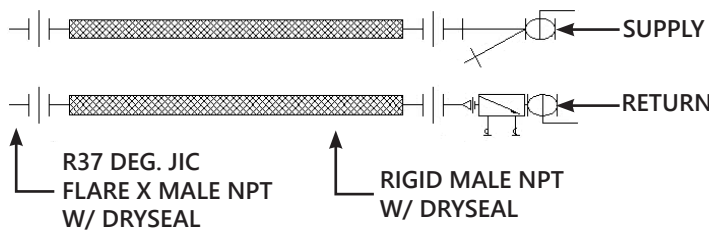

SUPPLY IS A COMBINATION Y-STRAINER/SHUT OFF. ONE TEST PORT AND DRAIN (BLOW DOWN) VALVE. RETURN IS BALL VALVE AND AUTOMATIC CIRCUIT SETTER COMBINATION WITH TWO TEST PORTS. BOTH HOSES ARE MALE BY MALE PIPE SWIVEL ADAPTOR. WORKING PRESURE/BURST PRESSURE 400/1600 PSI FOR 3/4" HOSE AND 500/2000 PSI FOR 1" HOSE. ALL ASSEMBLIES ARE UL-940VO RATED FOR FLAME RETARDANCY.

KIT #4 3/4" / 1.0"						
			9VW4	3	18	000
	3 - 3/4" 1 - 1.0"					
	18", 24", 30", 36" Hose Length					
	000 - Manual set flow rate					

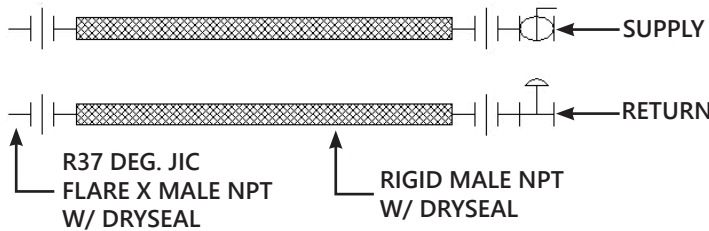

SUPPLY HAS 600 WOG BRASS BODIED BALL VALVE WITH ONE TEST PORT. RETURN HAS MANUAL CIRCUIT SETTER/SHUT OFF VALVE WITH TWO TEST PORTS. ASSEMBLIES ARE MALE PIPE BY MALE PIPE SWIVEL ADAPTER. WORKING PRESSURE/BURST PRESSURE 400/1600 PSI FOR 3/4" HOSE AND 500/2000 PSI FOR 1" HOSE. ALL ASSEMBLIES ARE UL-940VO RATED FOR FLAME RETARDANCY.

# WSH SERIES

## HORIZONTAL WATER SOURCE HEAT PUMP

### HOSE KITS (CONT'D)

#### KIT NUMBER 5 THRU NUMBER 6

KIT #5 3/4" / 1.0"						
				<b>9VW5</b>	<b>3</b>	<b>18</b>
				3 - 3/4" 1 - 1.0"		
				18", 24", 30", 36" Hose Length		
000 - Manual set flow rate						

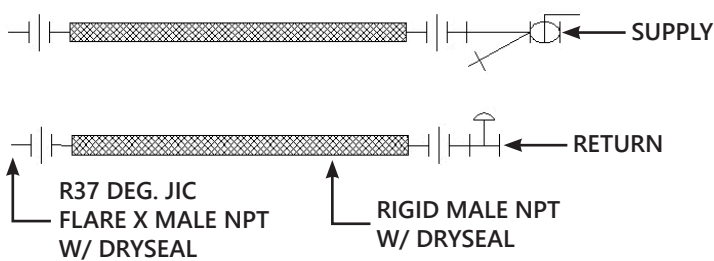

SUPPLY IS A COMBINATION Y-STRAINER/SHUT OFF. ONE TEST PORT AND DRAIN (BLOW DOWN) VALVE. RETURN HAS A MANUAL CIRCUIT SETTER/SHUT OFF VALVE WITH TWO TEST PORTS. BOTH HOSES ARE MALE PIPE BY MALE PIPE SWIVEL ADAPTER. WORKING PRESURE/BURST PRESSURE 400/1600 PSI FOR 3/4" HOSE AND 500/2000 PSI FOR 1" HOSE. ALL ASSEMBLIES ARE UL-940VO RATED FOR FLAME RETARDANCY.

KIT #6 3/4" / 1.0"						
				<b>9VW6</b>	<b>3</b>	<b>18</b>
				3 - 3/4" 1 - 1.0"		
				18", 24", 30", 36" Hose Length		
000 - Manual set flow rate						

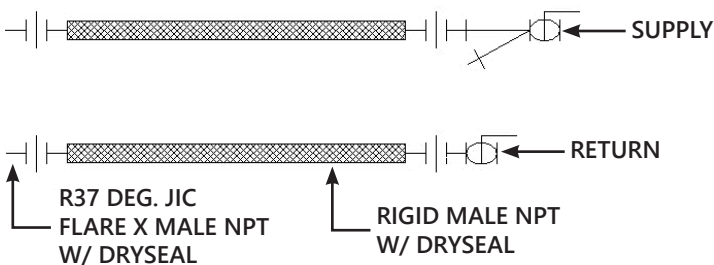

SUPPLY IS A COMBINATION Y-STRAINER/SHUT OFF. ONE TEST PORT AND DRAIN (BLOW DOWN) VALVE. RETURN HAS 600WOG BRASS BODIED BALL VALVE WITH ONE TEST PORT. ASSEMBLIES ARE MALE PIPE BY MALE PIPE SWIVEL ADAPTER. WORKING PRESURE/BURST PRESSURE 400/1600 PSI FOR 3/4" HOSE AND 500/2000 PSI FOR 1" HOSE. ALL ASSEMBLIES ARE UL-940VO RATED FOR FLAME RETARDANCY.

---

# WSH SERIES

## HORIZONTAL WATER SOURCE HEAT PUMP

### GUIDE SPECIFICATIONS

#### GENERAL

Equipment shall be completely assembled, piped, internally wired, fully charged with R-410A refrigerant and test operated at the factory. Filters, thermostat field interface terminal strip, and all safety controls are furnished and factory installed. The system water inlet and outlet connections shall be female NPT panel-mounted - No back-up wrench needed. The 5-ton and below equipment shall contain ETL, CETL and ISO-ARI 13256-1 listings and labels prior to leaving the factory.

#### AIR-TO-REFRIGERANT COIL

Internally finned, 3/8-inch copper tubes mechanically bonded to a configured aluminum plate fin shall be standard. Coils shall be leak tested at the factory to ensure the pressure integrity. The coil shall be leak tested to 450 psig and pressure tested to 650 psig. The tubes are to be completely evacuated of air and correctly charged with proper volume of refrigerant prior to shipment. The refrigerant coil distributor assembly shall be of orifice style with round copper distributor tubes. The tubes shall be sized consistently with the capacity of the coil. Suction header shall be fabricated from rounded copper pipe. A thermostatic expansion valve shall be factory selected and installed for a wide range of control.

#### AUTOMATIC FLOW DEVICES (OPTION)

The automatic flow kit shall contain a Hays Mesurflo® automatic flow control valve, two ball valves, two flexible hoses, a high flow Y-strainer, and may include a strainer blow-down and various other accessories. The automatic flow control valve shall be factory set to a rated flow, and shall automatically control the flow to within 10% of the rated value over a 40 to 1 differential pressure, operating range (2 to 80 PSID). Operational temperature shall be rated from fluid freezing, to 225°F. The valve body shall be constructed from hot forged brass UNS C37700 per ASTM B-283 latest revision. For more information pertaining to the automatic balancing hose kits, see literature documentation .

#### BALL VALVES (OPTION)

Ball valves shall be field installed between the unit and the supply and return lines of the loop to stop water flow to the unit in a maintenance or service situation.

Internal thermal overload protection is provided. Protection against excessive discharge pressure is provided by means of a high pressure switch. A loss of charge is provided by a low pressure safety.

#### BASIC CONTROLS

Units shall include the following controls and functions. Service test mode with diagnostic LED shall allow service personnel to check the operation of the WSHP and control system efficiently. Upon entering Test mode, time delays speed up, and the Status LED displays a code to indicate the last fault experienced. This mode provides easy fault diagnosis; based on the fault code that the status LED displays.

##### **24V Status LED**

Green light indicates 24V power to the control module.

##### **Nuisance Trip Protection**

Unit will attempt to start up to three times with a fault signal. If the fault continues, the unit locks out.

##### **Condensate Overflow Lock Out**

Electronic sensor mounted to the drain pan. When condensate pan liquid reaches an unacceptable level, the unit is automatically deactivated and placed in a lockout condition.

##### **Provide High and Low Pressure Switches.**

##### **Provide Condenser Coil Low Temperature Protection**

High/low voltage protection because of high or low voltage conditions

##### **Provide a random re-start timer**

To ensure a random delay in energizing each different WSHP unit to minimize peak electrical demand during start-up from different operating modes or after building power outages. Provide the circuit board with conformal coating (both sides of board) for humidity and condensation protection.

---

# WSH SERIES

## HORIZONTAL WATER SOURCE HEAT PUMP

### GUIDE SPECIFICATIONS (CONT'D)

**Provide Anti-short Cycle Timer, Alarm Relay**

Activated if the unit locks out.

**FIELD SELECTABLE SETTINGS:**

**5 Second Compressor Delay**

Blower starts before the compressor, attenuates compressor start up sound.

**45 Second Blower-off Delay**

Increases cooling efficiency.

**Dehumidification Mode**

Selects low speed fan operation for increased humidity removal.

**Provide the following, low water temperature and low coil temperature cutout options**

Optional 10 degree F. cutouts for applications where water temperature is below 50 degrees F. (requires antifreeze solution).

**Accessory Relays (2)**

Relays can be selected to cycle with either the fan or compressor.

Relay "1" can be configured for use with slow opening water valves (60 second pre-compressor initialization) and relay "2" can be configured for a 30 second post fan delay.

### ELECTRICAL

The unit control box shall contain all necessary devices to allow heating and cooling operation to occur from a remote wall thermostat. These devices shall be as follows:

**24 VAC energy limiting class II [50 VA (minimum) transformer]**

**24 VAC blower motor relay**

**24 VAC compressor contactor for compressor control**

Thermostat connections shall be provided for ease of hook-up to a terminal strip located in the unit's control box.

### ELECTRIC HEAT (OPTION)

Boilerless control electric heat shall be field supplied and wired to WSHP control panel. It shall be composed of a nichrome open wire coil designed for 2-kW per unit ton. The design consist of a single stage of electric heat used as a primary heating source when compressor lockout has occurred due to the entering water temperature falling below 55°F with an adjustable range between 25°F to 60°F. The electric heat option is not intended for secondary heat.

### HOSES (OPTION)

Hoses shall consist of a stainless steel outer braid with an inner core of tube made of a nontoxic synthetic polymer material. The hoses shall be suitable for water temperatures ranging between 33°F and 211°F without the use of glycol.

Indoor Blower Wheels are double width, double inlet (DWDI), forward curved, centrifugal type. They are statically and dynamically balanced for a smooth, quiet operation. The Class I housing is constructed of heavy gauge steel with die-formed inlet cones. Assemblies are field reversible to optimize blower performance.

Motors to be multi-speed, 230V, single phase, 60-Hz, permanent split capacitor (PSC) type, factory mounted to the blower assembly with rubber isolators.

---

# WSH SERIES

## HORIZONTAL WATER SOURCE HEAT PUMP

### GUIDE SPECIFICATIONS (CONT'D)

#### MOTORIZED WATER VALVE (OPTION)

When extreme fluid temperature conditions do not exist with an open loop system, a motorized water valve shall be applied to each water-source heat pump. The motorized valve shall stop flow to the unit, causing pressures to rise. This rise in pressure will halt pump operation to provide greater energy savings of the entire system.

#### PUMP MODULE (OPTION)

The pump module shall be a complete self contained pumping package for an earth-coupled heat pump system. The module shall consist of a single bronze pump, and a brass 3-way shut-off valve. These kits shall contain the necessary components for the installation, operation, and maintenance of the water circuit of a closed-loop distributed pumping application.

#### REFRIGERANT TUBING

The refrigerant tubing shall be copper. This system shall be free from contaminants and conditions such as drilling fragments, dirt and oil.

Coaxial Heat Exchanger, features a tube in tube coaxial water-to-refrigerant heat exchanger and constructed of a convoluted copper (optional cupronickel) inner tube and steel outer tube with a designed refrigerant working pressure of 450 PSIG (3100 kPa) and designed water side working pressure of no less than 400 PSIG (2750 kPa)

#### Control Module and Safety Devices:

The WSH\* unit comes standard with a control module that controls the units operation and monitors the safety controls that protect the compressor, heat exchanger, wiring and other components from damage caused by operating outside of design conditions.

#### Safety controls include the following:

- High pressure switch located in the refrigerant discharge line.
- Low pressure switch located in the refrigerant suction line.
- Water coil low temperature cutout sensor located on the heat exchanger to prevent unit operation below low temperature setting.
- Condensate overflow protection sensor located in the drain pan.

#### The control module includes the following features:

- **Anti-Short Cycle Timer** - 5 minute anti-short cycle protection for the compressor.

**NOTE: THE 5 MINUTE ANTI-SHORT CYCLE ALSO OCCURS AT POWER UP.**

- **Random Start** - The controller features a 5-80 second random start upon power up.
- **Low Pressure Bypass Timer** - The low pressure switch input is bypassed for the initial 120 seconds of a compressor run cycle to prevent nuisance low pressure lockouts.
- **Over / Under Voltage Shutdown** - Should a Over / Under Voltage condition be detected, the module will initiate a shutdown. Over / Under Voltage Shutdown is self resetting in that if the voltage comes back with range of 18.5VAC to 31VAC, then normal operation will be restored.
- **Alarm Relay** - The module has a set of contacts for remote fault indication. Contacts can be 24VAC output or converted to a dry contact.
- **Test Mode** - Test pins can be momentarily jumpered to enter into a 10 minute test mode period in which all time delays are sped up to 15 times. While in the test mode the LED Display will display a code representing the last fault in memory.

**NOTE: CONTINUED OPERATION OF THE UNIT IN THE TEST MODE CAN LEAD TO ACCELERATED WEAR AND PREMATURE FAILURE OF UNIT.**

---

# WSH SERIES

## HORIZONTAL WATER SOURCE HEAT PUMP

### GUIDE SPECIFICATIONS (CONT'D)

#### FAULT RETRY

While in the fault retry mode the LED Display will display a code representing retry and the fault code. The unit will initiate the anti-short cycle timer and try to restart after the delay. If 3 consecutive faults occur without satisfying the thermostat the control will go to lockout mode. The last fault causing the lockout will be stored in memory and displayed.

- **Lockout** - While in the lockout mode the LED Display will display a code representing lockout and the fault code.

The compressor relay is turned off immediately. During a lockout mode the alarm relay is activated. Lockout mode can be soft reset by turning the thermostat to the "OFF" position then back to the "HEAT" or "COOL" mode or hard reset via the power disconnect.

- **LED INDICATION** - Two LED indicators are provided as follows:

**Green:** Power LED indicates 18.5 - 31 VAC is present at the board.

**Yellow:** Test LED indicates the unit is operating the test mode.

- **LED DISPLAY** - A two digit display indicates the system mode and fault code, if present. See table 1 in installation instructions.



*AMERICAN-MADE. FAMILY OWNED.*



FIRST CO.  
P.O. BOX 270969 - DALLAS, TEXAS 75227  
PH. (214) 388-5751 | FAX (214) 388-2255  
[WWW.FIRSTCO.COM](http://WWW.FIRSTCO.COM)

**NOVEMBER 2024**