

Installation, Operation, & Maintenance

IOM 7205
Rev. B 03/26

COOL PAK AC (ECE) SPACE CONSTRAINED AIR CONDITIONERS WITH ELECTRIC HEAT

ecoseries
COOL-PAK

ATTENTION:

Read all instructions thoroughly and retain all manuals for future reference.

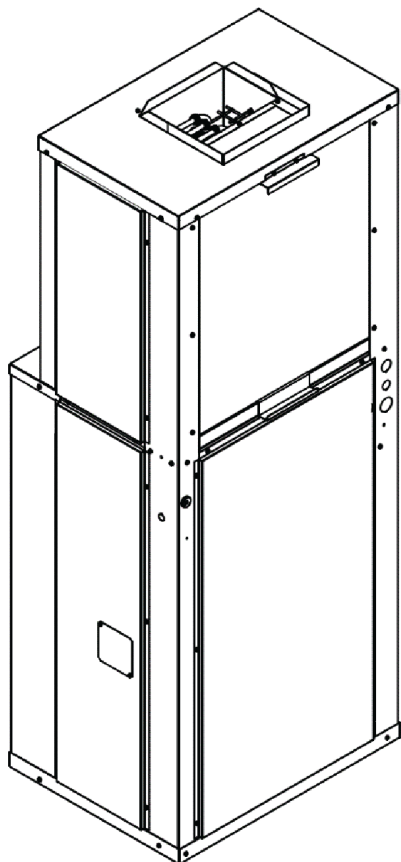

COPYRIGHT

The Manufacturer works to continually improve its products and as a result, it reserves the right to change design and specifications without notice.

The warranty may be void unless the Startup & Performance Checklist is completed and returned to the warrantor. If the COOL-PAK AC unit is not installed properly the warranty will be void as the manufacturer cannot be held accountable for problems that stem from improper installation.



WARNING



This appliance is not to be used by persons (including children) with reduced physical, sensory or mental capabilities, or lack of experience and knowledge, unless they have been given supervision or instruction concerning use of the appliance by a person responsible for their safety

Children should be supervised to ensure that they do not play with the appliance

Use adequate personal protection equipment when installing and performing maintenance. After switching off and locking-out an electrical disconnect, verify a safe condition with an electrical tester. Discharge a capacitor before handling any PSC motor and wiring. Use eye protection, cut resistant gloves and sleeves to protect against metal edges and screws.

Do not alter this product by using non-authorized parts. Such action voids all warranties or implied warranties and may result in adverse operation and performance and may be hazardous to service personnel and occupants. Company employees and/or contractors are not authorized to waive this warning.



TABLE OF CONTENTS



SAFETY CONSIDERATIONS	4
MODEL NOMENCLATURE	5
GENERAL INFORMATION	6
UNIT OPERATION	7
STORAGE	7
UNIT INSPECTION CHECKLIST	8
ECE UNIT DIMENSIONAL DATA	9
UNIT PHYSICAL DATA	10
ELECTRICAL DATA	11
INSTALLATION	12-19
ELECTRICAL	20-21
CONTROLS	22-24
BLOWER DATA	25-26
WIRING DIAGRAMS	27-31
CIRCUIT SCHEMATIC	32
STARTUP INSTRUCTIONS	33-34
STARTUP & PERFORMANCE CHECKLIST INSTRUCTIONS	34
TROUBLESHOOTING	35-36
OPERATION & MAINTENANCE	37-43
STARTUP & PERFORMANCE CHECKLIST	44
NOTES	45





SAFETY CONSIDERATIONS

1. READ THE ENTIRE MANUAL BEFORE STARTING THE INSTALLATION.
2. These instructions are intended as a general guide and do not supersede national, state, or local codes in any way.
3. Altering the product, improper installation, or the use of unauthorized factory parts voids all warranty or implied warranty and may result in adverse operation and/or performance or may result in hazardous conditions to service personnel and occupants. Company employees or contractors are not authorized to waive this warning.
4. This product should only be installed and serviced by a qualified, licensed, and factory authorized installer or service agency.
5. All “kits”, parts, and “accessories” used must be factory authorized when modifying this product. Refer and follow instructions packaged with the kits or accessories when installing.

RECOGNIZE THE FOLLOWING SAFETY NOTATIONS THROUGHOUT THIS MANUAL AND POSTED ON THE EQUIPMENT:





	WARNING	
Indicates a potentially hazardous situation or unsafe practices that could result in severe personal injury or death and/or damage to property.		

	NOTE	
Used to highlight suggestions, which may result in enhanced installation, reliability or operation.		

	WARNING	
	ELECTRIC SHOCK HAZARD	
Signifies potential electrical shock hazards that could result in personal injury or death.		

	CAUTION	
Indicates a potentially hazardous situation that may result in minor or moderate personal injury.		

	IMPORTANT	
Suggests important procedure steps to insure proper installation, reliability, or operation.		

	WARNING	
	FIRE OR EXPLOSION HAZARD	
Failure to follow safety warnings exactly could result in property damage, dangerous operation, serious injury, or death. Improper servicing could result in dangerous operation, serious injury, death, or property damage.		
<ul style="list-style-type: none"> • Before servicing, disconnect all electrical power to the unit. • When servicing controls, label all wires prior to disconnecting. Reconnect wires correctly. 		
Verify proper operation after servicing		

MODEL NOMENCLATURE

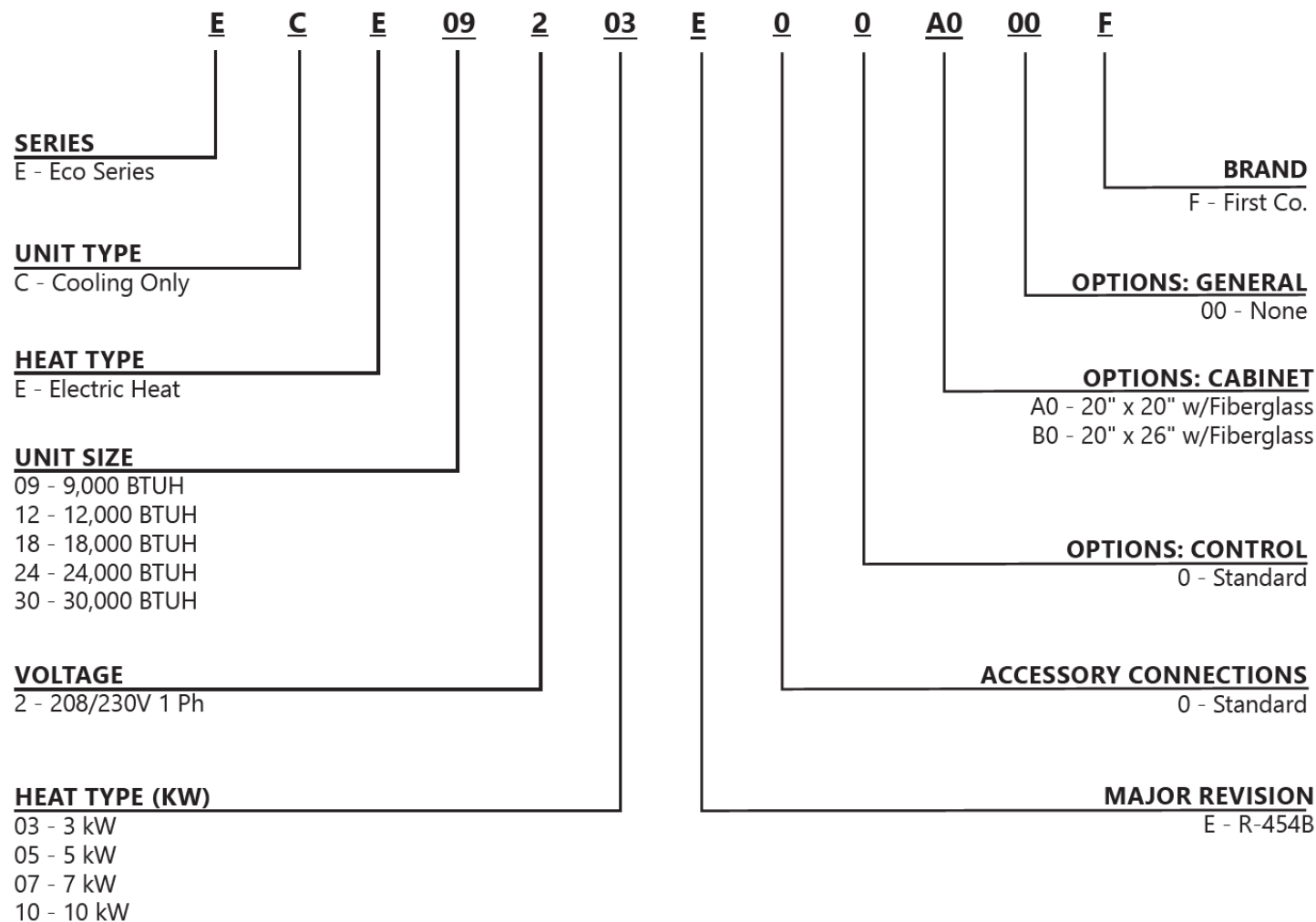



Figure 1 - Model Nomenclature

GENERAL INFORMATION



The Eco-series COOL-PAK AC models are a space constrained package air-conditioning unit with integrated electric heat or hot water. The unit is tested to AHRI 210/240 2023 and is in compliance with UL 60335-2-40 4th edition.





This unit may be installed at altitudes up to 10,000 ft. (3,048 m).



These instructions are given for the installation of the Eco Series COOL-PAK AC specifically. For any other related equipment, refer to the appropriate manufacturer's instructions.

	WARNING	
<p>This unit is certified for through-the-wall indoor installation only. It is NOT approved for mobile homes, recreational vehicles or outdoor applications. Such use could result in property damage, personal injury, or death.</p>		

	CAUTION	
<p>Do not operate this unit without an air filter in place.</p>		

	IMPORTANT	
<p>Do not operate this unit in any mode during building construction due to excessive airborne dust and debris. Do not operate this unit without an air filter in place. The manufacturer does not warrant equipment subjected to abuse.</p>		

	WARNING	
	ELECTRIC SHOCK HAZARD	
<p>Before servicing equipment, ALWAYS turn off all power to the unit. There may be more than one disconnect switch. Electrical shock can cause injury or death.</p>		

	NOTE	
<p>Material in this shipment has been inspected at the factory and released to the transportation agency in good condition.</p> <p>Upon receipt, a visual inspection of all cartons should be made immediately. Any evidence of rough handling or apparent damage should be noted on the delivery receipt in the presence of the carrier's representative.</p> <p>If damage is found, a claim should be immediately filed against the carrier.</p>		

	WARNING	
<p>Take extreme caution that no internal damage will result if screws or holes are drilled into the cabinet.</p>		

	NOTE	
<p>Remove shrink-wrap and all packaging materials before installation. Ensure louvered areas are free from obstructions before installation.</p>		

UNIT OPERATION



IMPORTANT



The unit is designed to operate at maximum 0.5 in.w.c external static pressure. Operation at higher E.S.P may cause equipment failure. For applications requiring higher static operation, please contact factory or the manufacture's sales representative.



WARNING



These instructions are intended as an aid to qualified, licensed, service personnel for proper installation, adjustment and operation of this unit. Read these instructions thoroughly before attempting installation or operation. Failure to follow these instructions may result in improper installation, adjustment, service or maintenance possibly resulting in fire, electrical shock, property damage, personal injury or death.

Unit Operating Range °F [°C]

Condition	Cooling	
	Min	Max
Outdoor DB	60 [15.6]	115 [46.1]
Indoor DB	60 [15.6]	90 [32.2]

Table 1 – Unit Operating Range

Note:

- 1) Operating ranges based off standard installation with "0" external static and standard Louvers. Operation with non-standard louvers may lower unit operating range.

STORAGE

Equipment should be stored in a clean dry, conditioned area with maximum temperatures up to 120°F [48.89°C] and minimum temperatures to 32°F [0°C]. Units should be stored upright and in an indoor environment. It is recommended to leave packaging on the unit until the installation is to begin.



WARNING



REFRIGERANT UNDER PRESSURE

Units are factory charged with refrigerant. Store units in a location that will minimize the potential for damage. Do not store the unit where sources of ignition are continuously present.

Do not use means to accelerate the defrosting process, or to clean the unit, other than those recommended by the manufacturer.

Be aware that refrigerants may not contain an odour.

Do not pierce or burn.



WARNING



DO NOT stack COOL-PAK units. Failure to follow these instructions may result in property damage, personal injury or death.

DO NOT operate units during the construction process. Mechanical components and filters could become clogged with dirt and debris, which can cause damage to the system.

The manufacture does not warrant equipment subjected to abuse. Construction debris can void warranties and liability for equipment failure, personal injury, and property damage.

UNIT INSPECTION CHECKLIST

Before preparing unit for installation, complete the inspection procedures below.

- 1) Visually inspect unit for any shipping damage. Damage must be reported immediately to the shipping company to make a claim.
- 2) Ensure that the carrier makes proper notation of any shortages or damage on all copies of the freight bill and completes a common carrier inspection report.
- 3) Verify that unit nameplates on the data label match the sales order or bill of lading (including, unit configuration, size and voltage).
- 4) Immediately before installation, remove unit front panel and verify that all electrical connections are tight and that there are no loose wires.
- 5) Verify that the refrigerant piping is free from any kinks and there is no interference between unit piping and sheet metal or electrical wires.
- 6) Remove the blower access panel and remove the foam packaging mount underneath the blower.
- 7) Check that the blower spins freely within the housing and there are no obstructions between the wheel and housing. The wheel can sometimes come loose in shipping.
- 8) Ensure that evaporator distributor tubes are not touching one another and that they are over the drain pan.
- 9) Check the air-coil fins for any damage during shipping.
- 10) Ensure that shipping brackets and screws are removed from condensing section. Refer to **Figure 2 - Shipping Bracket Removal**



NOTE



Remove the foam shipping block supporting the blower assembly.

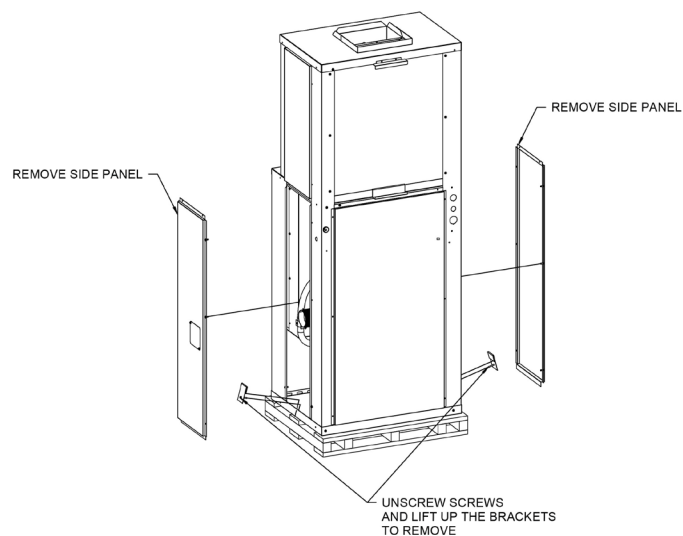
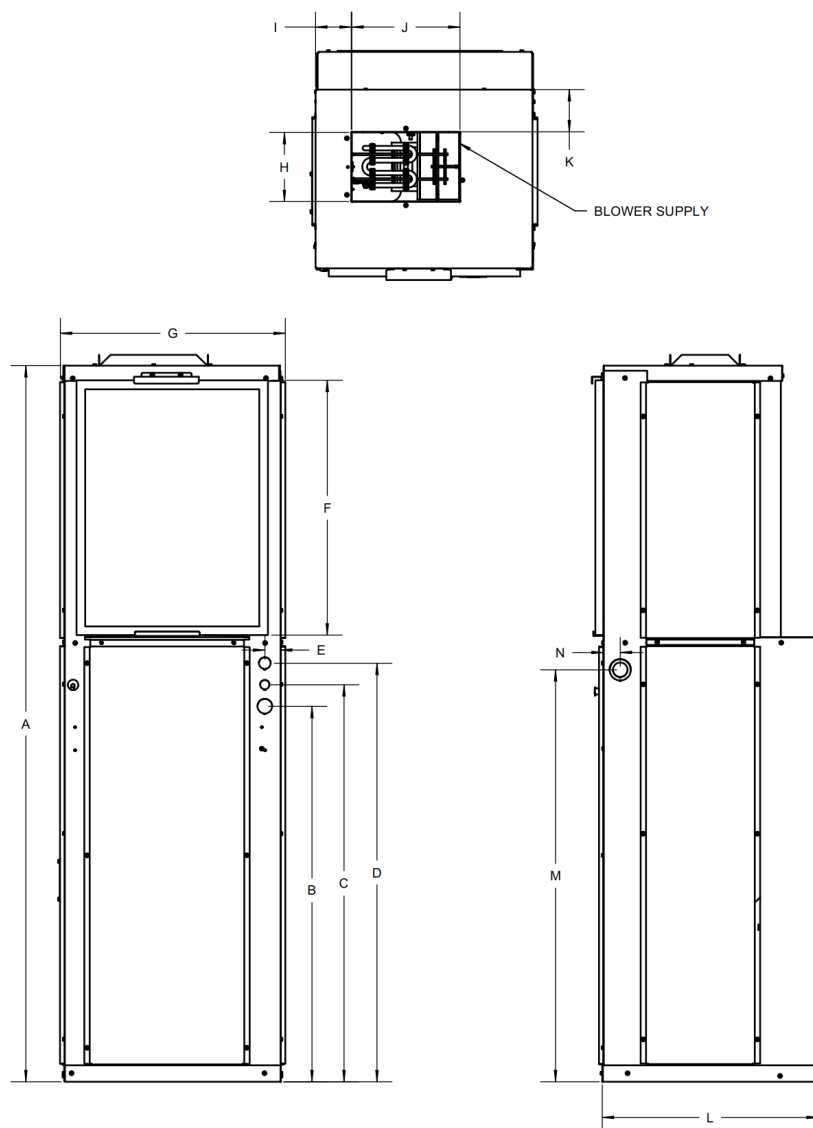

Figure 2 - Shipping Bracket Removal

ECE UNIT DIMENSIONAL DATA



DIMENSIONAL DATA														
MODEL	A	B	C	D	E	F	G	H	I	J	K	L	M	N
	CABINET DIMENSIONS							SUPPLY CONNECTIONS						
ECE09*	66.5 (168.91)	34.9 (88.65)	36.9 (93.73)	38.9 (98.81)	1.4 (3.56)	23.6 (59.94)	20.9 (53.10)	6.4 (16.26)	3.3 (8.38)	10.0 (25.40)	3.9 (9.91)	20.1 (51.10)	38.2 (97.02)	1.6 (4.06)
ECE12*	66.5 (168.91)	34.9 (88.65)	36.9 (93.73)	38.9 (98.81)	1.4 (3.56)	23.6 (59.94)	20.9 (53.10)	6.4 (16.26)	3.3 (8.38)	10.0 (25.40)	3.9 (9.91)	20.1 (51.10)	38.2 (97.02)	1.6 (4.06)
ECE18*	66.5 (168.91)	34.9 (88.65)	36.9 (93.73)	38.9 (98.81)	1.4 (3.56)	23.6 (59.94)	20.9 (53.10)	6.4 (16.26)	3.3 (8.38)	10.0 (25.40)	3.9 (9.91)	20.1 (51.10)	38.2 (97.02)	1.6 (4.06)
ECE24B*	66.5 (168.91)	34.9 (88.65)	36.9 (93.73)	38.9 (98.81)	1.4 (3.56)	23.6 (59.94)	20.9 (53.10)	6.4 (16.26)	3.3 (8.38)	10.0 (25.40)	3.9 (9.91)	20.1 (51.10)	38.2 (97.02)	1.6 (4.06)
ECE24A*	66.5 (168.91)	34.9 (88.65)	36.9 (93.73)	38.9 (98.81)	1.4 (3.56)	23.7 (60.20)	26.9 (68.33)	10.0 (25.40)	7.9 (20.10)	10.0 (25.40)	3.9 (9.91)	20.1 (51.10)	38.2 (97.02)	1.6 (4.06)
ECE30*	66.5 (168.91)	34.9 (88.65)	36.9 (93.73)	38.9 (98.81)	1.4 (3.56)	23.7 (60.20)	26.9 (68.33)	10.0 (25.40)	7.9 (20.10)	10.0 (25.40)	3.9 (9.91)	20.1 (51.10)	38.2 (97.02)	1.6 (4.06)

Table 2 – EHE Dimensional Data

UNIT PHYSICAL DATA

UNIT PHYSICAL DATA						
454B COOL PAK AC	ECE09	ECE12	ECE18	ECE24B	ECE24A	ECE30
Compressor (Quantity)	Rotary (1)				Scroll (two stage)	Scroll (1)
Compressor FLA	3.8	4.7	7.5	10.2	9.7	11.7
Factory Charge (R454b) lb. [kg]	2.5	3.0	3.9	5.4	4.2	5.4
	[1.13]	[1.36]	[1.76]	[2.43]	[1.9]	[2.44]
Minimum Room Area (m ²) [Ft ²]	3.41	4.11	5.32	7.34	5.74	7.37
	37	44	57	79	62	79
Minimum Air Flow (CFM) [m ³ /hr]	67	81	105	145	113	146
	115	138	178	246	193	247
ID MOTOR						
Motor (Quantity)	1	1	1	1	1	1
Fan Motor Type	ECM	ECM	ECM	ECM	ECM	ECM
Motor HP	1/4	1/4	1/3	1/3	1/3	1/2
Motor FLA	2.3	2.3	2.8	2.8	2.8	4.1
OD MOTOR						
Motor (Quantity)	1	1	1	1	1	1
Fan Motor Type	ECM	ECM	ECM	ECM	ECM	ECM
Motor HP	1/4	1/4	1/4	1/4	1/4	1/3
Motor FLA	2.3	2.3	2.3	2.3	2.3	2.8
ID BLOWER						
Blowers (Quantity)	1	1	1	1	1	1
Blower Wheel Size (D x W) in. [cm]	6 x 7	6 x 7	9 x 4	9 x 4	9 x 4	9 x 4
	[15.3 x 17.78]	[15.3 x 17.78]	[22.9 x 10.16]	[22.9 x 10.16]	[22.9 x 10.16]	[22.9 x 10.16]
EVAPORATOR COIL						
Dimensions (H x W) in. [cm]	24 x 16.25	24 x 16.25	24 x 16.25	24x22	24 x 16.25	24x22
	[61 x 41.275]	[61 x 41.275]	[61 x 41.275]	[61 x 55.88]	[61 x 41.275]	[61 x 55.88]
Face Area ft ² [m ²]	3.53 [0.33]	3.53 [0.33]	3.53 [0.33]	3.67 [0.34]	3.53 [0.33]	3.67 [0.34]
Rows	2	3	4	4	4	4
OD COIL						
Dimensions (H x W) in. [cm]	26 x 16.5	26 x 16.5	26 x 16.5	26 x 22.5	26 x 16.5	26 x 22.5
	[66 x 42]	[66 x 42]	[66 x 42]	[66 x 57]	[66 x 42]	[66 x 57]
Face Area ft ² [m ²]	3.0 [0.28]	3.0 [0.28]	3.0 [0.28]	4.1 [0.37]	3.0 [0.28]	4.1 [0.38]
Rows	2	3	4	4	4	4
MISCELLANEOUS						
Throwaway Filter Dim. in. [cm]	18 x 24	18 x 24	18 x 24	24 x 24	18 x 24	24 x 24
	[45.72 x 60.96]	[45.72 x 60.96]	[45.72 x 60.96]	[60.96 x 60.96]	[45.72 x 60.96]	[60.96 x 60.96]
Throwaway Filter Quantity	1	1	1	1	1	1
A2L Mitigation	NO	NO	NO	YES	YES	YES
Operating Weight lb. [oz]	288 [131]	289 [131]	290 [131]	305 [138]	290 [131]	315 [142]
Packaged Weight lb. [oz]	310 [141]	310 [141]	310 [141]	325 [147]	310 [141]	335 [152]

TABLE 3 UNIT PHYSICAL DATA

For installations in locations above 800 meters the room size and mitigation airflow must be adjusted with a factor from this chart

ALTITUDE CORRECTION FACTOR													
Altitude(m)	800	1000	1200	1400	1600	1800	2000	2200	2400	2600	2800	3000	3200
Altitude (ft)	2625	3281	39.7	4693	5349	5349	5906	6562	7874	8530	9186	9843	10499
Adj Factor (AF)	1.02	1.05	1.07	1.1	1.12	1.12	1.15	1.18	1.25	1.28	1.32	1.36	1.4

TABLE 4

ELECTRICAL DATA

ELECTRICAL DATA (208/240V 1-PH-60Hz)																	
UNIT MODEL		ELECTRICAL HEAT DATA						BLOWER DATA		CONDENSER DATA				MINIMUM CIRCUIT AMAPACITY		MAXIMUM CIRCUIT PROTECTION	
		KW		BTUH		TOTAL HEATING AMPS		EVAPORATOR MOTOR		COMPRESSOR		CONDENSER MOTOR					
		240V	208V	240V	208V	240V	208V	AMPS	HP	RLA	LRA	AMPS	HP	240V	208V	240V	208V
ECE09	-03	3	2.25	10230	7670	13	11	2.3	1/4	4	22	2.3	1/4	19	17	20	20
ECE12	-03	3	2.25	10230	7670	13	11	2.3	1/4	4.6	25	2.3	1/4	19	17	20	20
	-05	4.5	3.38	15350	11530	19	16	2.3	1/4	4.6	25	2.3	1/4	27	24	30	25
ECE18	-03	3	2.25	10230	7670	13	11	2.8	1/3	7.6	36	2.3	1/4	20	18	20	20
	-05	5	3.75	17060	12790	21	18	2.8	1/3	7.6	36	2.3	1/4	30	27	30	30
	-07	7	5.25	23880	17910	29	25	2.8	1/3	7.6	36	2.3	1/4	40	36	40	40
	-10	9.5	7.125	32410	24310	40	34	2.8	1/3	7.6	36	2.3	1/4	53	47	55	50
ECE24A	-05	5	3.75	17060	12790	21	18	2.8	1/3	10.2	58	2.3	1/4	30	27	30	30
	-07	7	5.25	23880	17910	29	25	2.8	1/3	10.2	58	2.3	1/4	40	36	40	40
	-10	9.5	7.125	32410	24310	40	34	2.8	1/3	10.2	58	2.3	1/4	53	47	55	50
ECE24B	-05	5	3.75	17060	12790	21	18	2.8	1/3	9.6	52	2.3	1/4	30	27	30	25
	-07	7	5.25	23880	17910	29	25	2.8	1/3	9.6	52	2.3	1/4	40	36	40	40
	-10	9.5	7.125	32410	24310	40	34	2.8	1/3	9.6	52	2.3	1/4	53	47	55	50
ECE30	-05	5	3.75	17060	12790	21	18	4.1	1/2	10.5	71	2.8	1/3	32	28	35	30
	-07	7	5.25	23880	17910	29	25	4.1	1/2	10.5	71	2.8	1/3	42	37	45	40
	-10	9.5	7.125	32410	24310	40	34	4.1	1/2	10.5	71	2.8	1/3	55	48	55	50

TABLE 5

Notes

1. All ECE and models use single point power for unit operations
2. Refer to wiring diagrams in the ECE IOM for additional details
3. Wire sizes should be determined in accordance with National Electric Codes
4. Units are rated for 208/230V, but MOP, MCA values are calculated at 208/240V
5. For all models, Minimum voltage is 197V, Maximum voltage is 252V

ELECTRIC HEAT RATINGS						
MODEL SIZE	240V		230V		208V	
	kW	BTU/H	kW	BTU/H	kW	BTU/H
72*09203E00A*	3.00	10250	2.76	9450	2.25	7700
72*12203E00A*	3.00	10250	2.76	9450	2.25	7700
72*12205E00A*	4.50	15400	4.14	14150	3.38	11550
72*18203E00A*	3.00	10250	2.76	9450	2.25	7700
72*18205E00A*	5.00	17100	4.6	15700	3.75	12800
72*18207E00A*	7.00	23900	6.44	22000	5.25	17950
72*18210E00A*	9.50	32450	8.74	29850	7.13	24350
72*24205E00A*	5.00	17100	4.6	15700	3.75	12800
72*24207E00A*	7.00	23900	6.44	22000	5.25	17950
72*24210E00A*	9.50	32450	8.74	29850	7.13	24350
72*24205E00B*	5.00	17100	4.6	15700	3.75	12800
72*24207E00B*	7.00	23900	6.44	22000	5.25	17950
72*24210E00B*	9.50	32450	8.74	29850	7.13	24350
72*30205E00B*	5.00	17100	4.6	15700	3.75	12800
72*30207E00B*	7.00	23900	6.44	22000	5.25	17950
72*30210E00B*	9.50	32450	8.74	29850	7.13	24350

TABLE 6

INSTALLATION

INSTALLATION PRECAUTIONS

CAUTION

Always wear appropriate personal protective equipment (PPE) when installing and servicing these units.

WARNING

Use multiple people when moving and installing these units. Failure to do so could result in injury or death.

CAUTION

Contact with metal edges and corners can result in injury. Wear protective gloves when handling. Exercise caution when installing and servicing unit.

Observe the following precautions for typical installation.

- Always use proper tools and equipment
- No wiring or any work should be attempted without first ensuring the unit is completely disconnected from the power source and locked out. Also, verify that a proper permanent and uninterrupted, ground connection exists prior to energizing power to the unit.
- Review unit nameplate and wiring diagram for proper voltage and control configurations. This information may vary from unit to unit.
- Units must be installed leveled to ensure proper drainage and operation.
- Be sure that the drain pan is free from foreign material prior to start up.

WARNING

Components rotate at high speeds when the unit is in operation.

Do not touch any rotating component with any object. Damage to the equipment and personal injury can occur.

- Check filter media installation to ensure that it is installed correctly. Use the directional arrows or other information on the filter to determine the proper flow direction.
- Ensure air distribution system does not exceed the external static rating of the unit.

WARNING

When soldering and brazing, have a fire extinguisher available. When soldering and brazing close to valves or sensitive components, heat shields or wet rags are required to prevent damage to the valves or components.

IMPORTANT

Damaged insulation must be repaired or replaced before the unit is placed back into operation. Insulation loses its insulating properties when wet, damaged, separated or torn.

CAUTION

When servicing this equipment, ensure that the reversing valve, expansion device, filter drier and other components are specifically designed for R-454B refrigerant.

INSTALLATION (continued)

WARNING

FIRE OR EXPLOSION HAZARD

Failure to following this warning could result in personal injury, death and/or property damage.

Do not attempt any sealed system repair without first recovering the entire refrigerant charge. R-454B refrigerant and oil mixture could ignite in the presence of a brazing torch flame. Completely recover the refrigerant charge using both the high and low sides of the system and purge the sealed system with nitrogen before brazing any component or tubing.

Work with extreme caution to minimize the risk of refrigerant ignition while installing and servicing a system containing a flammable refrigerant. Control the work environment as much as possible while potentially flammable vapors are present. Inform all persons on site about the risks of the nature of the work underway and the necessary safety precautions. Do not work in confined spaces. Test the work area for refrigerant in the air using an intrinsically safe A2L refrigerant leak detector before beginning work. Have a dry powder or CO2 fire extinguisher available. Use proper tools designed for A2L class refrigerants. While working near A2L refrigerants, use only non-sparking tools. Open flames and other ignition sources must not be present except during brazing. Brazing must only take place on evacuated and nitrogen purged refrigerant lines and components that are open to the atmosphere.

Consult local building codes and current editions of the National Electrical Code (NEC) NFPA 70. In Canada, refer to current editions of the Canadian electrical code CSA CEC22.1

UNIT LOCATION

WARNING

Installation and service must be performed by a licensed professional installer (or equivalent), service agency. Attempting to install or repair this unit without such background may result in product damage, personal injury or death.

The COOL-PAK AC is designed for through-the-wall installation. The interior portion of the unit is surrounded by a closet with a rear access **Figure 5**. The vertical discharge allows for ducting to the top of the room for best air circulation and elimination of cold drafts on occupants.

IMPORTANT

These units are for indoor installation **ONLY!**

Provisions should be made to allow access to the indoor side of the unit for installation and inspection. The closet or access panel opening must be centered with the exterior wall opening and must be large enough to accommodate the installation of the Cool-Pak Sleeves.

3-in. of unobstructed clearance must be maintained around the COOL-PAK AC chassis on all sides for adequate airflow to achieve optimum performance. These guidelines give minimum spacing requirements only. It is acceptable to go beyond these limits at any time. At least 27 in. of unobstructed space should be provided in front of the access door to permit removal of the unit, should repair and inspection be required.

The installer must adhere strictly to all local and national code requirements pertaining to the installation of this equipment. All units are designed for indoor use only, and are agency listed for installation with clearances specified in **Table 7 - Clearance Requirements**. This includes the cabinet, discharge plenum and connecting ducts.

INSTALLATION (continued)

NOTE
Do not locate two units adjacent to each other on an inside corner or where they may exhaust into each other.

NOTE
The COOL-PAK units are designed for quiet operation. However, all air conditioning equipment will transfer a level of noise to the conditioned space. This should be considered when planning the location of the equipment.

NOTE
The Architectural Louver must be installed prior to the installation of the COOL-PAK AC unit into the sleeve.

UNIT CLEARANCE REQUIREMENTS

Service clearance must be provided for future maintenance and service. A minimum of 29 in. [73.66 cm] open area must be left unobstructed in front of the access panels.

The louver side must be kept free from any obstructions to air flow. The unit must be installed at least 4 feet [1.22m] from electric meters, gas meters, regulators, and relief equipment.

CLEARANCE REQUIREMENTS		
MINIMUM CLEARANCE	INCHES	CM
Horizontal distance between units	12	30
Vertical distance between units	60	152
Distance above ground level	6	15
Distance above finished floor	6	15
Distance above a garage floor	18	46

Table 7 - Clearance Requirements

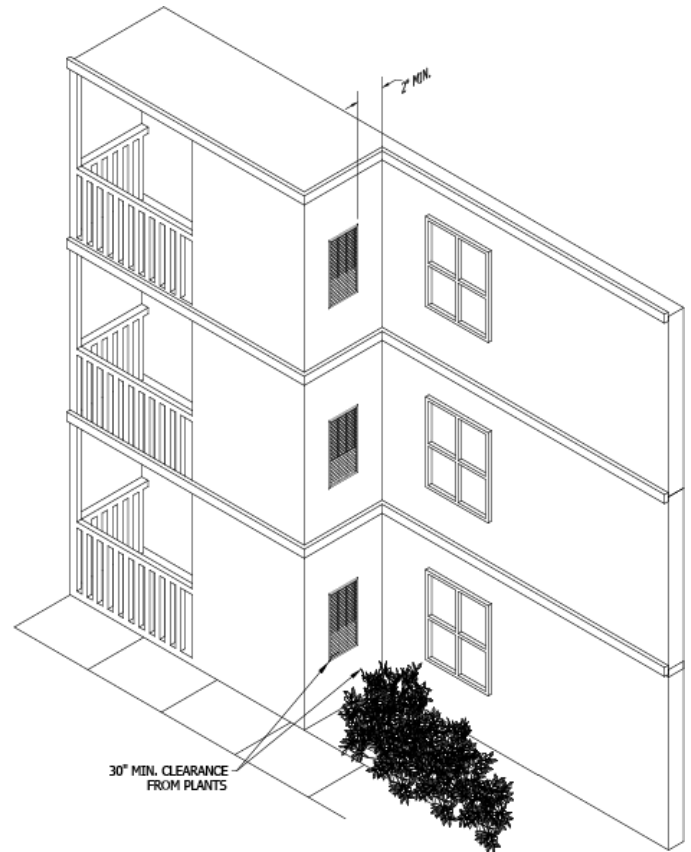

Figure 3 - Clearance Requirements

INSTALLATION (continued)

WALL SLEEVE INSTALLATION

Refer to installation instruction packed with the wall sleeve to assemble and mount into the wall. Before unit installation, verify that sleeve components are not damaged and that the drain line is unobstructed free of leaks.

Check all seals to ensure that they are in position and un-damaged. Ensure that the wall sleeve is sloped toward the exterior of the building. Securely fasten the Architectural louver to the front of the sleeve using the supplied hardware.

CAUTION

A masonry wall opening must be properly constructed with a lintel for wall support. Wall openings must be flashed and sealed. The unit must be level, front to back, side to side. Refer to CLEARANCE REQUIREMENTS section in this manual for more information.

CAUTION

Seal exposed joints to prevent water and outside air infiltration into the closet, which can cause improper unit operation and may cause damage the unit and other property.

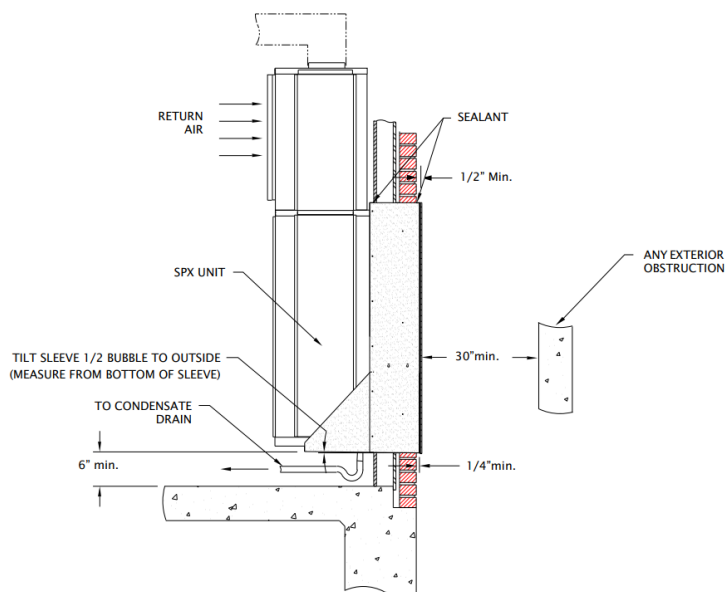

Figure 4 – Wall Sleeve Mounting

IMPORTANT

After sleeve installation, ensure that the gap in-between the wall and seal is insulated and is in contact with the sleeve sides.

IMPORTANT

Apply a high grade non-hardening sealant approved for exterior use between the sleeve and the structure, on the inside and outside walls, to prevent air and water from migrating inside

1. Between the edge of the sleeve and the structure
2. On the inside/outside walls.

INSTALLATION (continued)

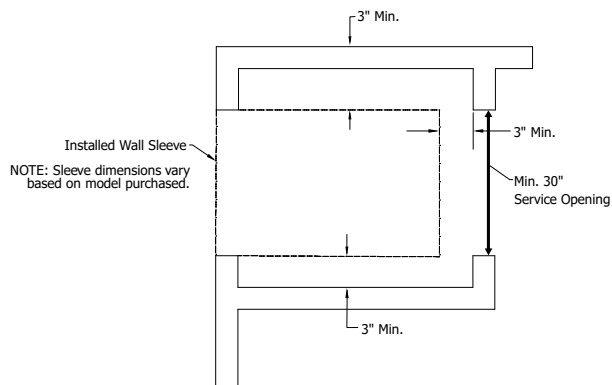

Figure 5 - Rear Sleeve Installation

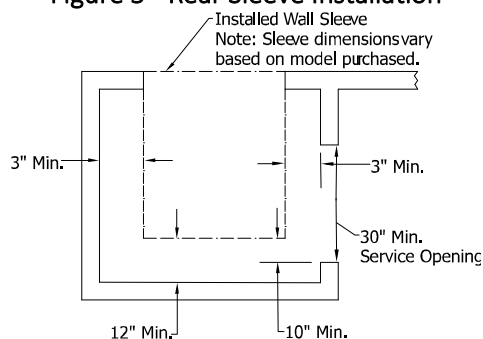

Figure 6 - Side Sleeve Installation

- “A” Cabinet (Size 09-24A) Wall Sleeve rough-in opening is 44 in. (H) [111.76 cm] x 21-5/8 in. (W) [54.93 cm].
- “B” Cabinet (Size 24B & 30B) Wall Sleeve rough-in opening is 44 in. (H) [111.76 cm] x 27-5/8 in. (W) [70.17 cm].
- Bottom of opening should be approximately 6 in. [15.24 cm] above the floor



IMPORTANT



Sleeve should be installed in exterior wall prior to constructing closet.



NOTE



Additional insulation is required on the internal condensate connections whenever the unit is operated in an area subject to freezing temperatures.

INSTALLATION (continued)

PACKAGED UNIT INSTALLATION



IMPORTANT



All ductwork must be installed in accordance with National Fire Protection Assoc. Codes 90A and 90B.

- 1) Before installing the unit in the sleeve be sure to go through the unit inspection check-list
- 2) Open the rear access door to grab loose items such as a electrical disconnect.
- 3) Ensure that properly sized ductwork is in place to mate to the connections on the Cool-Pak.
- 4) Ensure that the wall sleeve is installed correctly into the wall and is secured before installing unit. Also ensure that the sleeve has the proper slope towards the exterior of the building.
- 5) After removing the construction debris guard, check the bottom of the sleeve pan to ensure that it is sloped toward the building exterior. Ensure that the bottom of the pan and drain are clear of obstruction and are operational.
- 6) Slide the unit on to the sleeve and push from the bottom until the front of the unit is aligned with the front of the sleeve.
- 7) Inspect the sleeve seal to ensure that it is properly secured and aligned. Use a high-grade non-hardening sealant to close any gaps that may exist between the seal and the wall of the sleeve.
- 8) Check that the unit is completely settled on all four sides against the wall sleeve and seals.



NOTE



The unit is fully engaged in the sleeve if the top sleeve is in contact with the blower section of the unit. The condensing section should sit 3.5" deep into the sleeve.



CAUTION



If unit is not sealed properly, water and/or outside air will infiltrate the closet which may cause improper unit operation and can cause damage to the unit and/or property.

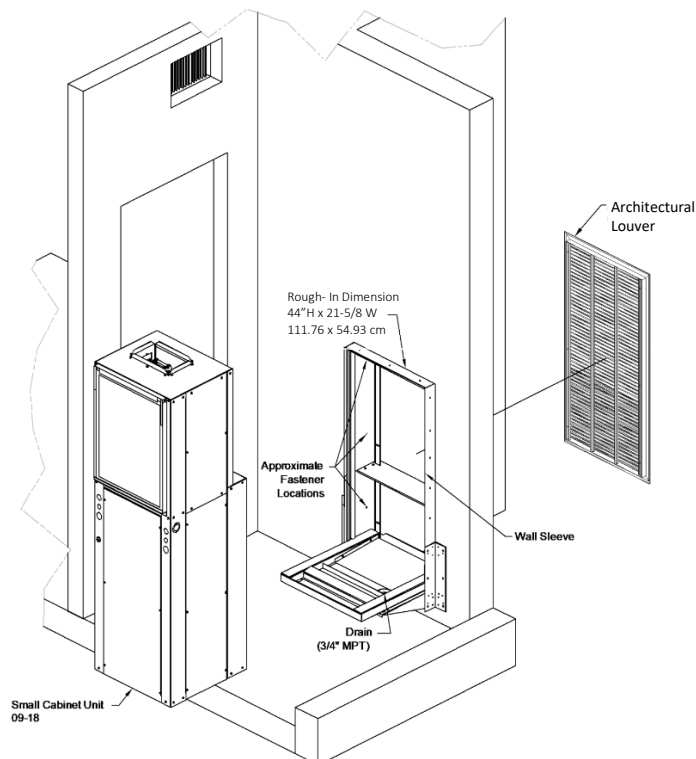

Figure 7 - Small Cabinet Installation

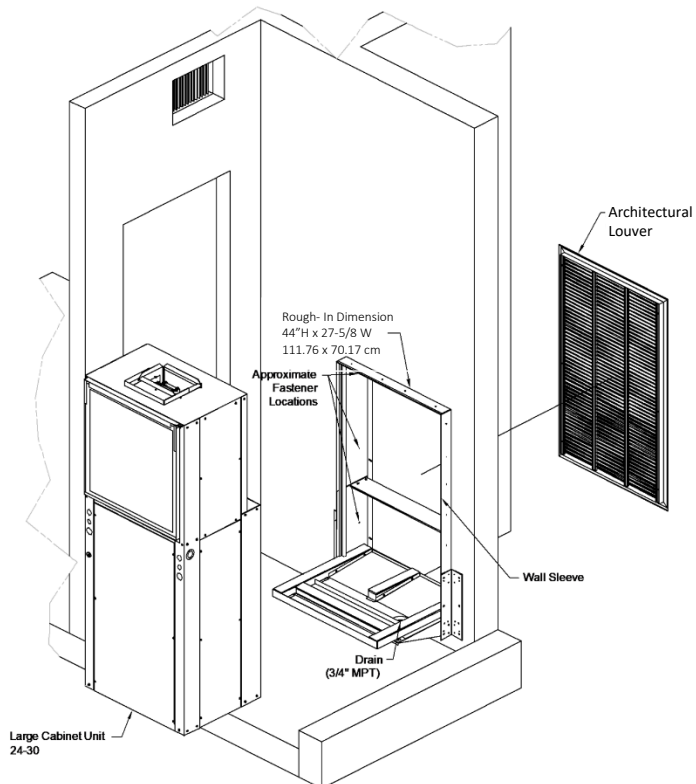

Figure 8 - Large Cabinet Installation

INSTALLATION (continued)

DUCTWORK

Discharge ductwork is normally used with these units. When return air ductwork is required, the unit is supplied with 1 in. [2.54 cm] thick filter rack/duct collar for connection of return air ductwork. All ductwork must be installed in accordance with National Fire Protection Assoc. Codes 90A and 90B.

Supply and Return ducts must be sized properly as to not exceed static pressure capabilities of the unit. Ducts should be adequately insulated to prevent condensation and to minimize heat loss. A flexible connector is recommended for supply air connections on metal duct systems.

DISCHARGE DUCTING

All Ductwork must conform to industry standards of good practice as described in ASHRAE System Guide. The transition piece from the unit discharge to the duct distribution system must not have an angle greater than 30° or severe loss of air performance can result.

Do not connect the full duct size to the unit discharge collar without using a transition piece down to the size of the unit discharge collar. With metal material, the sides of the elbow and entire branch duct should be internally lined with acoustic insulation for sound attenuation.

The ductwork should be configured such that there is no line of sight between the unit discharge and the distribution diffusers.

RETURN AIR DUCTING

Return air duct can be brought in through a wall louver and then to the unit. The return duct system will normally consist of flexible connector at the unit and a trunk duct to the return air louver. With metal duct material, the return air duct should be internally lined with acoustic insulation for sound attenuation.

A 1 in. [2.54 cm] air duct collar flange is included on the filter rack for ducted return air application. A flexible duct collar can then be attached between a duct transition and the return air ductwork. The return air duct transition must be the same size as the return air coil face area. Be sure to allow for proper clearance to allow for filter change outs.

AIR FILTER

All indoor return air must be filtered. The preferred methods are listed below.

1. Use the factory supplied filter kit which attaches to the inlet of the evaporator.
2. Use the filter kit supplied with the access panel which accepts an 24 in. [60.96 cm] x 24 in. [60.96 cm] x 1 in. [2.54 cm] throwaway type of filter.
3. Any field installation of an air filter, means must be provided, for use of a disposable filter which is no smaller than the face area of the evaporator coil.

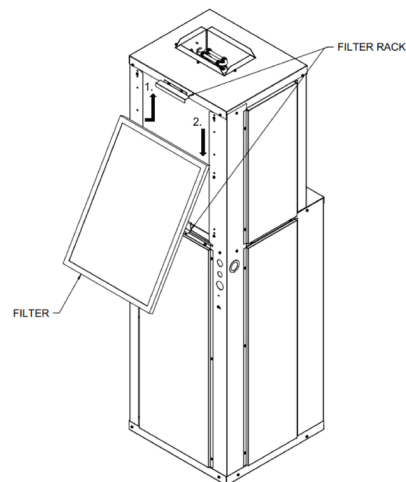

Figure 9 - Air Filter Installation

FRESH AIR VENT

The COOL-PAK units come standard with an optional fresh-air vent that can be used to provide ventilation to the condition space.

If the panel is removed, the condenser fan pushes outdoor air into the indoor space. The amount of conditioned air depends on the unit size and cannot be adjusted.

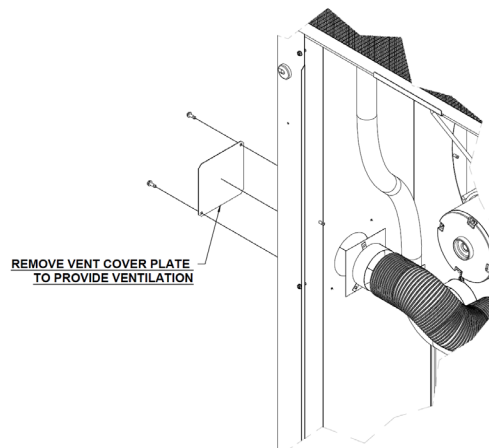

Figure 10 - Fresh Air Vent

INSTALLATION (continued)

CONDENSATE DRAIN

The COOL-PAK is designed so that the wall sleeve is the principle drain pan. Drain tubing is factory installed which drains evaporator condensate through the bottom of the unit which then is allowed to drain into the wall sleeve pan.

Condensate drain lines must be installed with adequate slope to ensure positive drainage. Prior to unit installation ensure that the drain is unobstructed and leak free.

! **CAUTION** !

On units with plastic drain pans, the drain connection must be hand tight only.

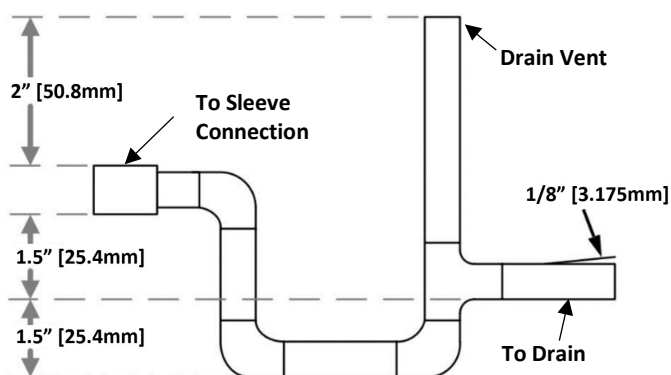

Figure 11 - Condensate Drain

i **NOTE** i

While preparing unit for installation, ensure that the drain tubing from the evaporator is securely attached to the copper nipple in the pan under the compressor. The wall sleeve has a 3/4 in. NPT nipple located in the bottom for connection to a drain. A trap is required in the condensate drain line from the wall sleeve to prevent sewer gas from escaping into the room.

ELECTRICAL

HIGH VOLTAGE



IMPORTANT



Electrical work associated with the installation of this appliance must comply with the National Electrical Code (NEC). Other local or regional electrical and building code requirements may apply.

In Canada electrical work associated with the installation of this appliance must comply with CE CSA C22



WARNING



The unit cabinet must have an uninterrupted / unbroken ground to minimize personal injury if an electrical fault should occur

. Failure to do so can cause electrical shock resulting in severe personal injury or death



WARNING



Do not bypass or eliminate safety devices

Ensure field wiring complies with local and national fire, safety, and electrical codes. Ensure voltage supply is within limits shown on unit rating plate. Contact the local power company for correction of improper voltage. Refer to the unit rating plate for recommended circuit protection device.



WARNING



Electrically ground the unit. Connect ground wire to ground lug. Failure to do so can result in injury or death.



WARNING



USE COPPER CONDUCTORS ONLY

The unit cabinet must have an uninterrupted and unbroken ground to minimize personal injury if an electrical fault should occur. Provide ground circuit in accordance with all applicable national and local codes.

All wiring must comply with local and national code requirements. Units are provided with wiring diagrams and nameplate data to provide information required for necessary field wiring.



WARNING



ELECTRIC SHOCK HAZARD



Disconnect all power supplies before servicing. Lock out/tag out to prevent accidental electrical shock.

NOTE: There may be multiple power sources supplying the unit.



WARNING



Use copper conductors only. Install all parts and panels before operation of unit. Failure to follow these warnings can result in personal injury or death.

Units are provided with a class 2 transformer for 24VAC control circuits. Should any add-on accessory or component also have a class 2 transformer furnished, care must be taken to prevent interconnecting outputs of the two transformers by using a thermostat with isolating contacts.



WARNING



Connect ground wire to ground terminal marked "GND". Failure to properly ground the unit may result in personal injury or death.



CAUTION



Any device furnished by the factory for field installation must be wired in strict accordance with the associated wiring diagram. Failure to do so could damage components and void warranties.

ELECTRICAL (continued)

208 VOLT OPERATION

All 208-240 Volt units are factory wired for 240 Volt operation. For 208 Volt operation; on the primary side of the transformer (line voltage), move black wire from the 230 volt tap to the 208 volt tap. See note on unit wiring diagram for instructions.

THERMOSTAT REQUIREMENTS

A minimum of a 1C/1H thermostat is required to operate the COOL-PAK AC. Thermostat connections are as follows:



THERMOSTAT CONNECTIONS KEY		
LETTER	COLOR	DESCRIPTION
C	BROWN	Transformer 24VAC Common
R	RED	Transformer 24VAC Hot
G	GREEN	Evaporator Blower
Y1	YELLOW	Compressor call
Y2	BLUE	Compressor Full Call (ECE24A Only)
W2	WHITE	Electric Heat

Table 8 - Thermostat Connections Key

THERMOSTAT INSTALLATION

Use 18 AWG wire with color-coded insulation (35°C minimum) up to 100 ft. in length (31 m). Use 16 AWG wire if more than 100 ft. of wire is required.

The Thermostat should be located on an interior wall in a larger room, away from supply duct draft. Position the thermostat back plate against the wall so that it appears level and so the thermostat wires protrude through the middle of the back plate mounting holes and drill holes with a 3/16 in. bit. Install supplied anchors and secure plate to the wall. Thermostat wire must be 18 AWC wire.

	WARNING	
Transformers are multi-voltage, it is crucial to refer to unit wiring diagram as well as unit voltage to ensure proper connections and operation safety.		

CONTROLS

ECO SERIES CONTROL MODULE

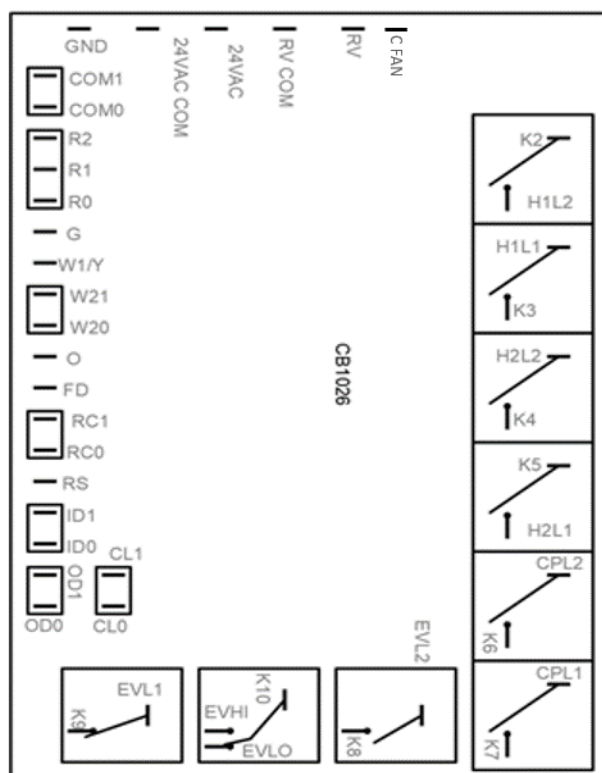

Figure 12 - ECO Series Control Module

POWER-UP

When power is first applied to the control, all timers are reset. The control will execute a random start delay before allowing normal operation of outputs, and a compressor anti short cycle delay (6 minute) before allowing the compressor output to be energized. While the control is operating, all of the inputs are continuously monitored for a change in the desired operating status.

RANDOM START DELAY

There will be a control random start delay which will vary from 10 to 60 seconds, which will be executed before energizing outputs when the control is powered up. All control outputs remain off during the random start delay.

ANTI-SHORT CYCLE DELAY

After the compressor output has been energized the control will execute a 6-minute anti short cycle delay from the time the compressor is de-energized, before allowing the compressor output to be energized again. A 6-minute anti short cycle delay will be present at control power up, before allowing the compressor output to be energized.

POWER INTERRUPTIONS

If the power to the control is interrupted for less than 100 milliseconds, the control shall resume operation at the same point in the timing cycle if the compressor output is not energized. Relays may temporarily drop out during the power interruption. Power interruptions greater than 100 milliseconds are to reset the control as a power- sequence. If the power to the control is interrupted for more than 40 milliseconds with the compressor output energized, the compressor output will be de-energized, and the control will execute a short cycle delay before allowing the compressor to operate.

CONTROLS (continued)

COOLING OPERATION

STEADY STATE COOLING

When the “W1/Y” input is present, and the compressor is not being held off by the anti-short cycle timer, the control will operate in steady state cooling. In steady state cooling, the compressor and condenser fan are energized. After a 7 second delay the evaporator fan is energized. For units with 2-stage compressors, if the only the “W1/Y1” input is present, the control will operate in low speed cooling, energizing the low speed evaporator fan. If the “Y2” input is applied with a “W1,Y1” input, the unit will operate in full speed cooling and energize the high speed evaporator fan. If the W2 input is applied to the control, the first stage auxiliary heat output will be energized immediately and the second stage auxiliary heat output will be energized after 15 seconds. The compressor and condenser outputs will be shut off and the evaporator fan will switch to low speed. When the “W2” input is removed, both auxiliary outputs will be turned off immediately, and the control will return to steady state cooling mode, assuming the “W1/Y” input is still present. When the “W1/Y” input is removed, the compressor and condenser fan will be turned off immediately. For 2 stage units, if a “Y2” input is applied without a “W1/Y1”, the compressor will not energize, however the high speed evaporator fan will energize. The high-speed evaporator fan will be turned off following a 45 second blower off delay.

LOW AMBIENT SHUTDOWN

When the control is operating in steady state cooling, and the “INDOOR” input is applied (temperature 30°F [-1] and below), the control will immediately de-energize the compressor and condenser fan. The high-speed evaporator will be turned off following a 45 second blower off delay. The compressor will go into an anti-short cycle delay for 6 minutes.

LOW AMBIENT COOLING LOCKOUT

When the control is operating in steady state cooling and the “COOLING LOCKOUT” input is applied (Outside Temperature of 40°F [4.4°C] or less) the control will continue to operate for 10 minutes. After 10 minutes, if the “COOLING LOCKOUT” is still active the cooling operation will be locked out for 30 minutes and run high speed evaporator during the lockout. After 30 minutes the control will be returned to normal operation.

AUXILIARY HEATING OPERATION

THERMOSTAT CALL FOR AUXILIARY HEAT

If the “W2” thermostat input is present without a “W1/Y” input, the control will operate in the auxiliary heat mode. The low-speed evaporator fan and the first stage auxiliary heat outputs will be energized immediately when the “W2” input is received. After a 15 second staging delay, the second stage auxiliary heat output will be energized. When the “W2” input is removed, all of the outputs will be turned off immediately.

If the “W2” thermostat input is present with a “W1/Y” input, the control will switch the system to auxiliary heat mode and will de-energize the compressor and condenser fan immediately.

A2L SENSING AND MITIGATION

Units charged with over 4lbs (1.81kg) of R454B refrigerant are shipped with a factory installed refrigerant leak detector attached to the evaporator coil. In the event that a refrigerant leak is detected, the controls will disable the compressor operation, and energize the evaporator fan to disperse the leaked refrigerant. The unit will operate in this mitigation state until the sensor no longer detects a refrigerant leak, for a minimum time of 5 minutes. Once the mitigation period has ended, the unit will return to its normal operation based on the current thermostat inputs.

LOW ROOM AMBIENT AUXILIARY HEAT

If the “RS” low room temperature input becomes active (switch closes), the control will operate in the auxiliary heat mode, regardless of any other control inputs. The low-speed evaporator fan and the first stage auxiliary heat outputs will be energized immediately when the “RS” input is received. After a 15 second staging delay, the second stage auxiliary heat output will be energized. When the “RS” input is removed, all of the outputs will be turned off immediately.

CONTROLS (continued)

FRONT DESK SHUTDOWN OPERATION

If the front desk shutdown input "FD" is removed (switch opens), operation based upon the "W1/Y", "W2" and "G" thermostat input will be prohibited. Auxiliary heat operation based upon the low room ambient temperature input "RS" is the only heating or cooling operation that will be allowed. When the "FD" input is re-applied (switch closes), the control will return to normal operation based upon the thermostat inputs.

THERMOSTAT INPUT OPERATION (W1/Y, W2)

If both "W1/Y" and "W2" thermostat inputs are active, the control will lock out or interrupt the operation of the compressor.

FIELD SPEEDUP MODE

The field speedup mode is entered by applying R (24VAC) to W1/Y (active) and closing the cooling lockout sensor switch (24VAC applied to the terminal). The field speedup mode is automatically canceled after 5 minutes. While in the field speedup mode, control timings will be reduced as follows:

Random Start Delay	0 Seconds
Short Cycle Delay	5 seconds
Cooling Blower off Delay	0 Seconds
Auxiliary Heat Staging Delay	1 Second

BLOWER DATA

ECE BLOWER DATA												
MODEL	Motor Tap	Motor Speed	IWC STATIC PRESSURE									
			0.10		0.20		0.30		0.40		0.50	
			SCFM	W	SCFM	W	SCFM	W	SCFM	W	SCFM	W
ECE09203*A	1	T1 ^H	317	51	300	49	281	49	263	49	244	48
	2	T2 ^C	358	64	341	63	322	62	303	62	285	61
	3	T3	510	128	493	127	474	127	456	126	437	125
	4	T4	459	103	441	102	423	101	404	101	385	100
ECE12203*A	1	T1 ^H	358	64	341	63	322	62	303	62	285	61
	2	T2 ^C	459	103	441	102	423	101	404	101	385	100
	3	T3	552	152	535	151	516	151	498	150	479	149
	4	T4	510	128	493	127	474	127	456	126	437	125
ECE12205*A	1	T1 ^H	358	64	341	63	322	62	303	62	285	61
	2	T2 ^C	459	103	441	102	423	101	404	101	385	100
	3	T3	552	152	535	151	516	151	498	150	479	149
	4	T4	510	128	493	127	474	127	456	126	437	125
ECE182203*A	1	T1	392	47	366	47	343	47	311	43	267	35
	2	T2 ^C	723	155	696	155	673	155	641	151	598	143
	3	T3	820	206	793	206	770	206	738	202	695	194
	4	T4 ^H	723	155	696	155	673	155	641	151	598	143
	5	T5	820	206	793	206	770	206	738	202	695	194
ECE182205*A	1	T1	514	69	487	69	464	69	432	65	389	57
	2	T2 ^C	723	155	696	155	673	155	641	151	598	143
	3	T3	820	206	793	206	770	206	738	202	695	194
	4	T4 ^H	723	155	696	155	673	155	641	151	598	143
	5	T5	820	206	793	206	770	206	738	202	695	194
ECE182207*A	1	T1	514	69	487	69	464	69	432	65	389	57
	2	T2 ^C	723	155	696	155	673	155	641	151	598	143
	3	T3	820	206	793	206	770	206	738	202	695	194
	4	T4 ^H	723	155	696	155	673	155	641	151	598	143
	5	T5	820	206	793	206	770	206	738	202	695	194
ECE182210*A	1	T1	514	69	487	69	464	69	432	65	389	57
	2	T2 ^C	723	155	696	155	673	155	641	151	598	143
	3	T3	820	206	793	206	770	206	738	202	695	194
	4	T4 ^H	723	155	696	155	673	155	641	151	598	143
	5	T5	820	206	793	206	770	206	738	202	695	194
ECE24205*A	1	T1	573	81	550	87	526	93	504	100	483	106
	2	T2 ^{Clow}	696	122	673	128	650	134	627	141	607	148
	3	T3 ^{Chigh}	909	232	886	239	863	245	840	251	820	258
	4	T4 ^H	975	279	953	285	929	291	907	297	886	304
	5	T5	784	162	762	168	738	174	716	180	695	187
ECE24207*A	1	T1	573	81	550	87	526	93	504	100	483	106
	2	T2 ^{Clow}	696	122	673	128	650	134	627	141	607	148
	3	T3 ^{Chigh}	909	232	886	239	863	245	840	251	820	258
	4	T4 ^H	909	232	886	239	863	245	840	251	820	258
	5	T5	975	279	953	285	929	291	907	297	886	304

TABLE 9

^C Factory Default Cooling

^H Factory Default Electric Heat Airflow

T3 is reserved for high static operation

Two Stage Systems Use T2 for Low Speed Compressor Operation and T3 for High Speed Compressor Operation

Blower performance data based on a dry coil at 70°F DB EAT with a standard 1" clean air filter

BLOWER DATA

ECE BLOWER DATA												
MODEL	Motor Tap	Motor Speed	IWC STATIC PRESSURE									
			0.10		0.20		0.30		0.40		0.50	
			SCFM	W	SCFM	W	SCFM	W	SCFM	W	SCFM	W
ECE24210*A	1	T1	573	81	550	87	526	93	504	100	483	106
	2	T2 ^{low}	696	122	673	128	650	134	627	141	607	148
	3	T3 ^{high}	909	232	886	239	863	245	840	251	820	258
	4	T4 ^H	909	232	886	239	863	245	840	251	820	258
	5	T5	975	279	953	285	929	291	907	297	886	304
ECE24205*B	1	T1	512	65	490	71	466	78	444	84	423	91
	2	T2 ^C	849	196	826	202	803	208	780	215	760	222
	3	T3	957	265	934	271	910	277	888	284	867	290
	4	T4 ^H	849	196	826	202	803	208	780	215	760	222
	5	T5	957	265	934	271	910	277	888	284	867	290
ECE24207*B	1	T1	512	65	490	71	466	78	444	84	423	91
	2	T2 ^C	849	196	826	202	803	208	780	215	760	222
	3	T3	957	265	934	271	910	277	888	284	867	290
	4	T4 ^H	849	196	826	202	803	208	780	215	760	222
	5	T5	957	265	934	271	910	277	888	284	867	290
ECE24210*B	1	T1	512	65	490	71	466	78	444	84	423	91
	2	T2 ^C	849	196	826	202	803	208	780	215	760	222
	3	T3	957	265	934	271	910	277	888	284	867	290
	4	T4 ^H	887	219	864	225	841	231	818	237	798	244
	5	T5	957	265	934	271	910	277	888	284	867	290
ECE30205*B	1	T1	637	136	614	137	586	134	557	128	527	122
	2	T2 ^C	1032	338	1009	339	981	336	952	330	922	324
	3	T3	1098	395	1074	396	1047	393	1017	387	987	381
	4	T4 ^H	1032	338	1009	339	981	336	952	330	922	324
	5	T5	1098	395	1074	396	1047	393	1017	387	987	381
ECE30207*B	1	T1	637	136	614	137	586	134	557	128	527	122
	2	T2 ^C	1032	338	1009	339	981	336	952	330	922	324
	3	T3	1098	395	1074	396	1047	393	1017	387	987	381
	4	T4 ^H	1032	338	1009	339	981	336	952	330	922	324
	5	T5	1098	395	1074	396	1047	393	1017	387	987	381
ECE30210*B	1	T1	637	136	614	137	586	134	557	128	527	122
	2	T2 ^C	1032	338	1009	339	981	336	952	330	922	324
	3	T3	1098	395	1074	396	1047	393	1017	387	987	381
	4	T4 ^H	1064	364	1040	365	1013	362	983	356	953	350
	5	T5	1188	484	1164	485	1137	482	1107	476	1077	470

TABLE 10

^C Factory Default Cooling

^H Factory Default Electric Heat Airflow

T3 is reserved for high static operation

Two Stage Systems Use T2 for Low Speed Compressor Operation and T3 for High Speed Compressor Operation

Blower performance data based on a dry coil at 70°F DB EAT with a standard 1" clean air filter



WARNING



ELECTRIC SHOCK HAZARD



High efficiency brushless DC motors have line voltage power applied at all times. Disconnect power before servicing. Low voltage thermostat demand and board algorithms will control its use.

WIRING DIAGRAMS

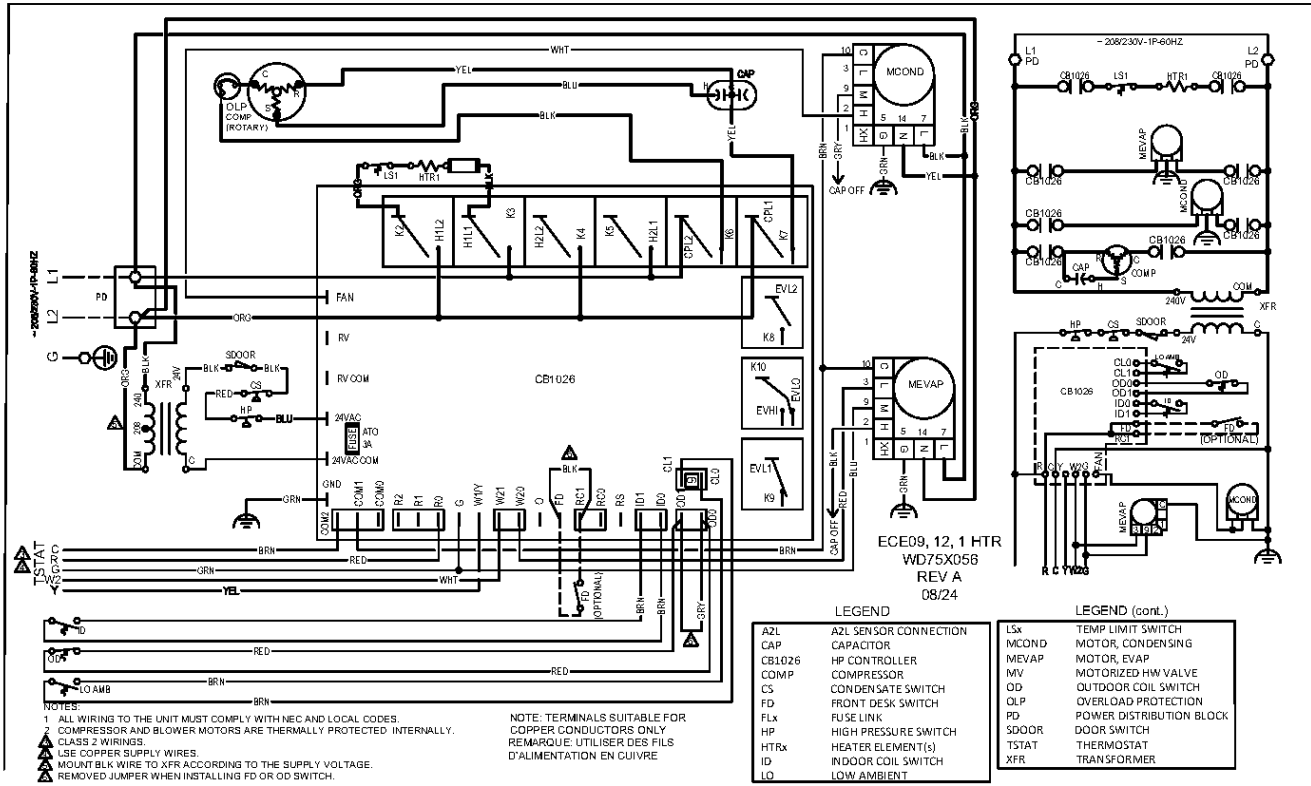

Figure 13 - ECE09, 12, 1 HTR WD75X056

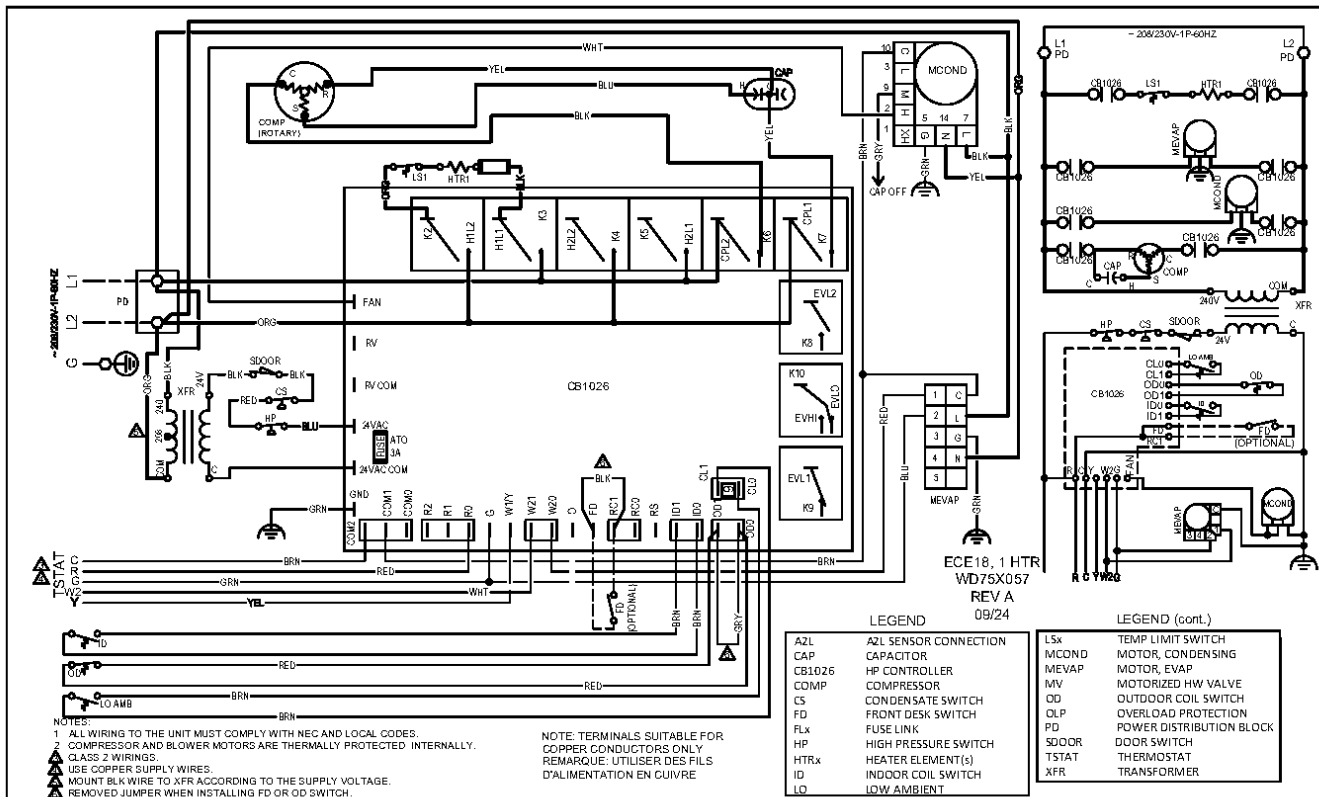

Figure 14 - ECE18, 1 HTR WD75X057

WIRING DIAGRAMS (continued)

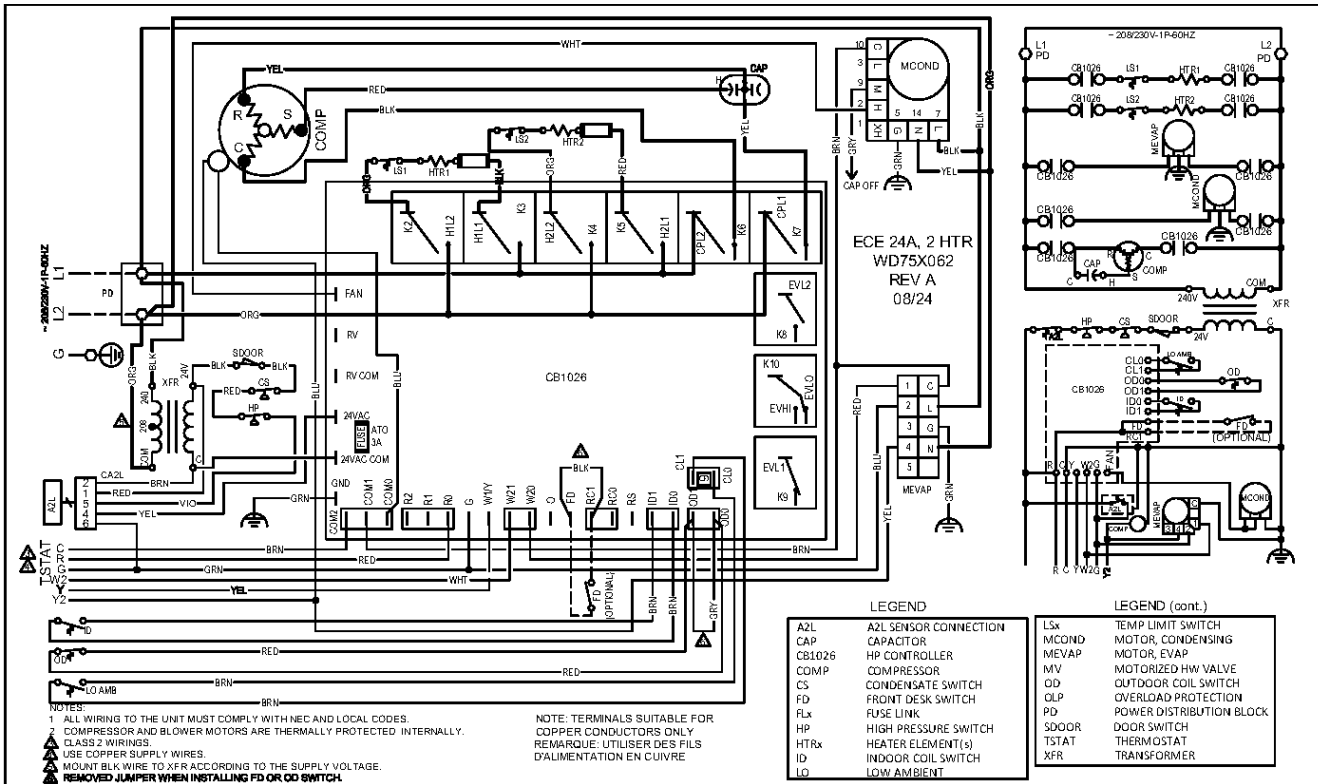

Figure 17 - ECE 24A, 2 HTR WD75X062

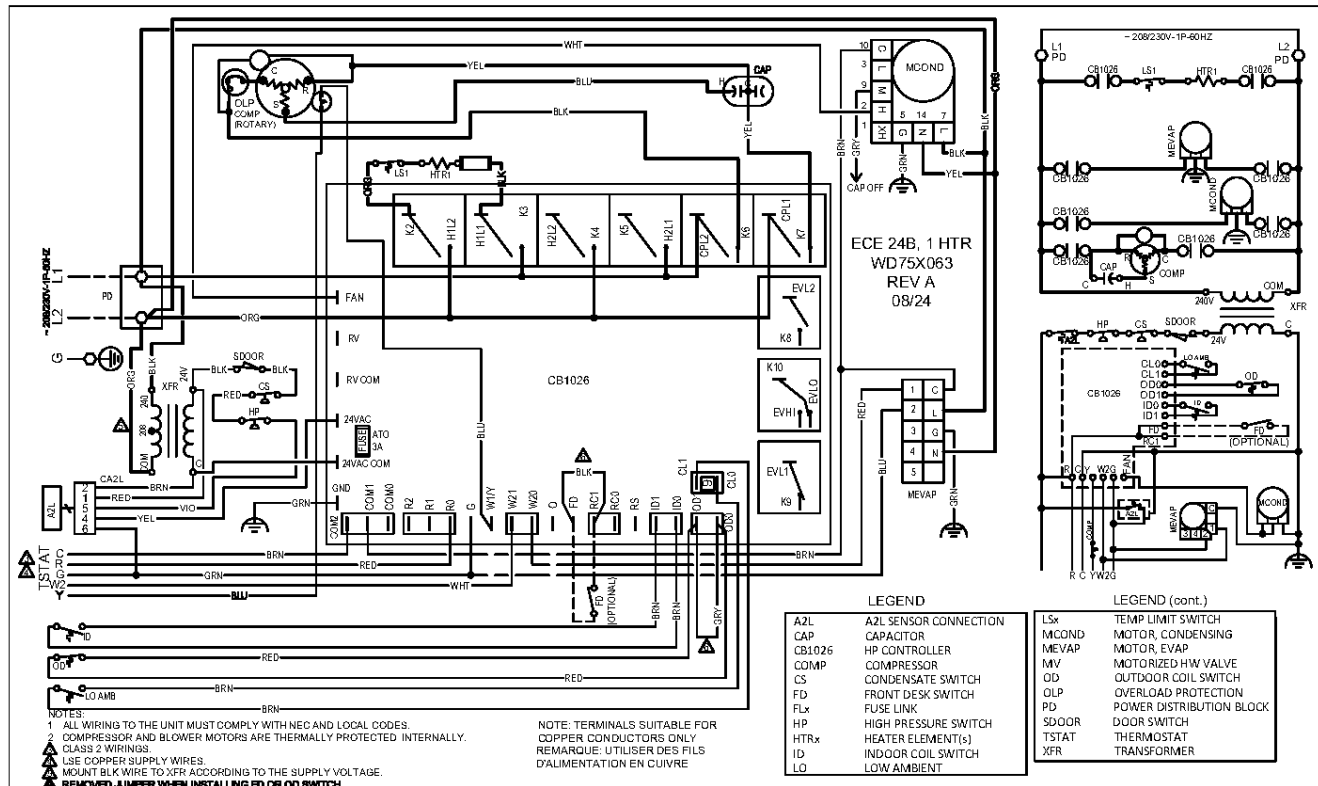

Figure 18 - ECE 24B, 1 HTR WD75X063

WIRING DIAGRAMS (continued)

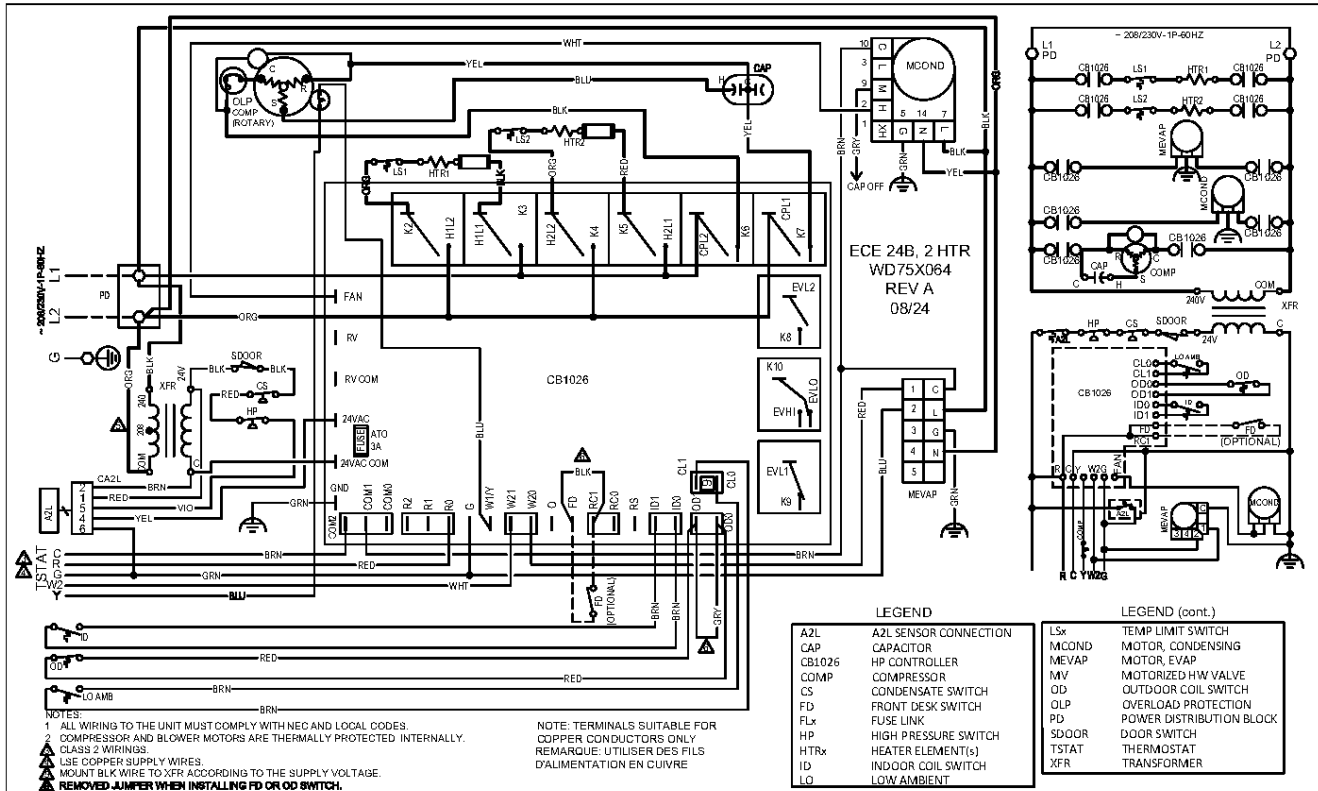

Figure 19 - ECE 24B, 2 HTR WD75X064

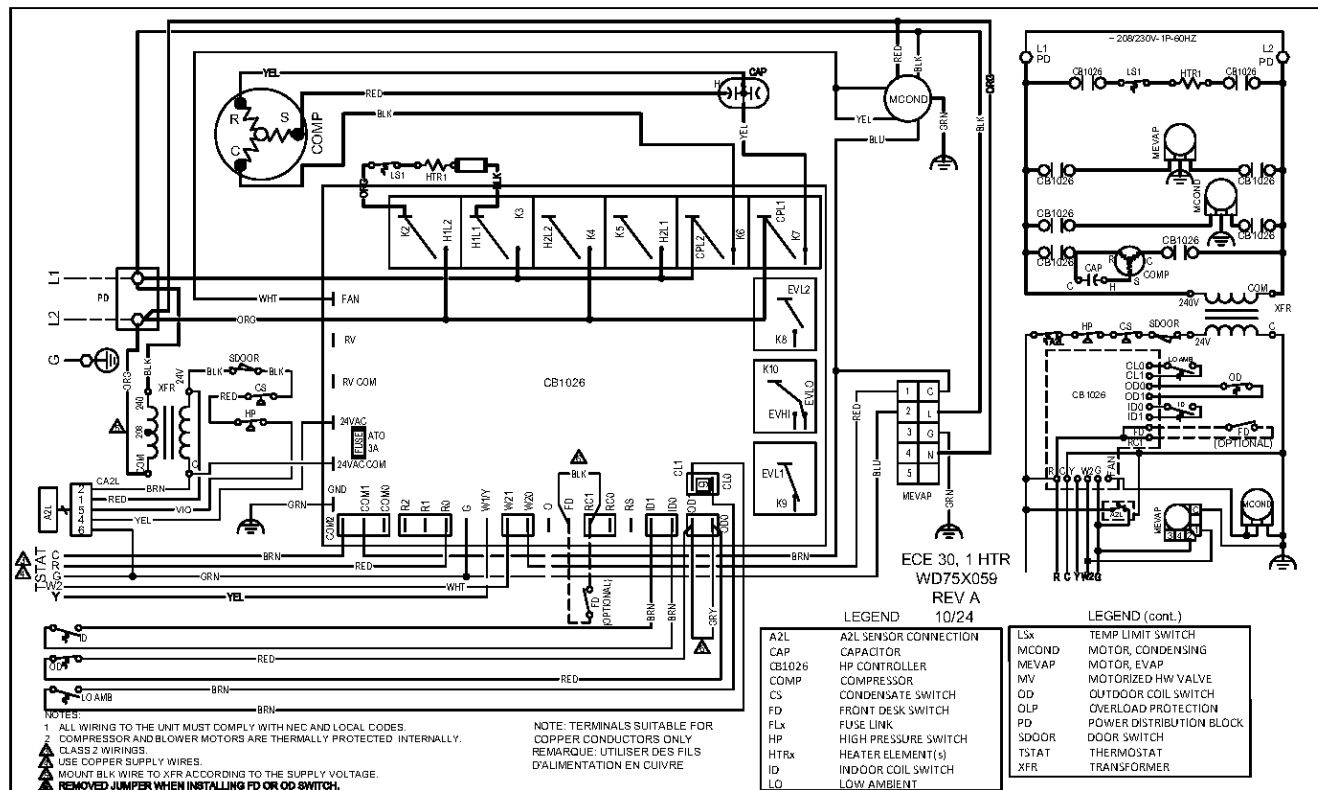

Figure 20 - ECE 30, 1 HTR WD75X059

WIRING DIAGRAMS (continued)

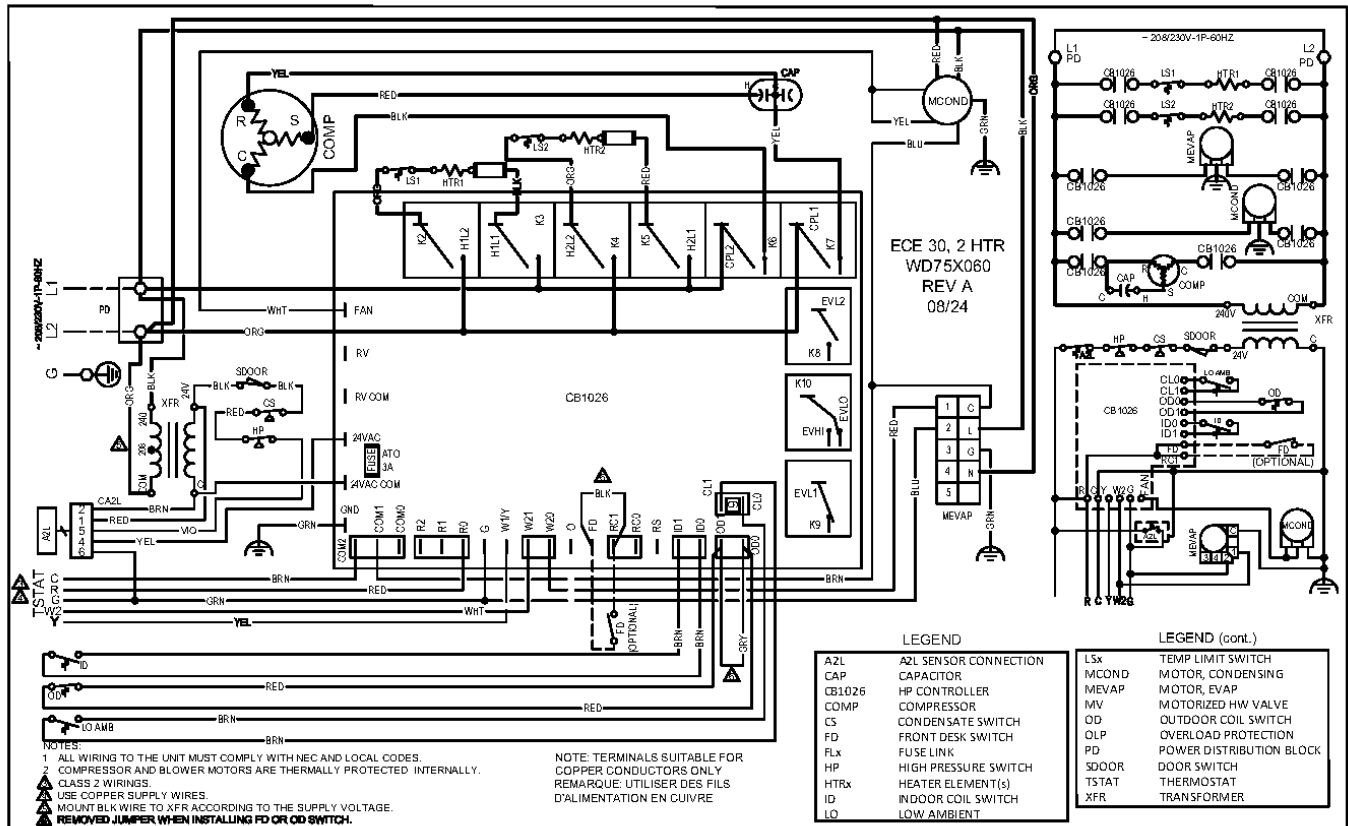

Figure 21 - ECE 30, 2 HTR WD75X060

Circuit Schematic

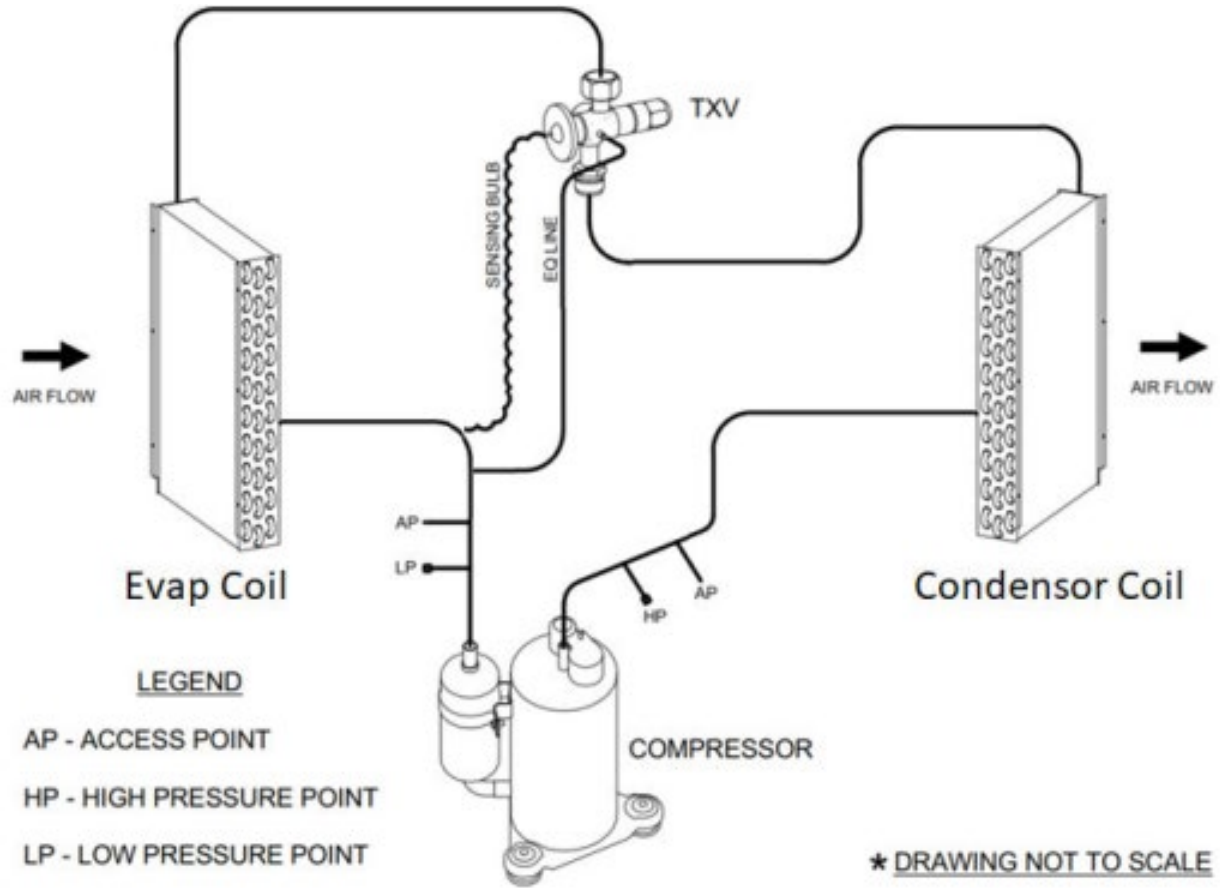





Figure 22 - Circuit Schematic

STARTUP INSTRUCTIONS

PRE-STARTUP CHECKS

Before start-up, thoroughly check all the components. Optimal operation of equipment requires cleanliness. Often after installation of the equipment, additional construction activities occur. Protect the equipment from debris during these construction phases.



	WARNING	
	FIRE OR EXPLOSION HAZARD	
<u>IMPROPER HANDLING OF REFRIGERANTS CAN CAUSE INJURY, EXPLOSION AND DEATH</u>		
<ul style="list-style-type: none"> • It is illegal to release refrigerant into the atmosphere. Refrigerant released into an enclosed space will displace oxygen causing unconsciousness and death. • If an indoor refrigerant leak is suspected, thoroughly ventilate the area before beginning any work • DO NOT purge or allow refrigerant to be released into an interior space • Contact with liquid refrigerant can cause frostbite and blindness. Avoid skin contact with liquid refrigerant, wear goggles and gloves when working with refrigerants. Seek medical help immediately if any refrigerant contact with skin or eyes occurs • Never burn refrigerant as highly toxic gas will be produced • Only EPA certified technicians should handle refrigerants. • In Canada technicians must be ODP / ODS certified to handle refrigerants • Follow all EPA regulations 		

	WARNING	
Do not exceed the maximum operating pressure listed on the unit rating plate.		

	WARNING	
Do not supply power to unit with the compressor terminal box cover removed.		

	WARNING	
	ELECTRIC SHOCK HAZARD	
Disconnect all power supplies before servicing. Lock out/tag out to prevent accidental electrical shock.		

	WARNING	
Install all parts and panels before operation of unit. Failure to follow these warnings can result in injury or death.		

	WARNING	
Transformers are multi-voltage, it is crucial to refer to unit wiring diagram as well as unit voltage to ensure proper connections and operation safety.		

STARTUP INSTRUCTIONS



WARNING



- Always wear eye protection.
- When fan coil is operating, some components are operating at high speeds. Do not touch rotating items with any object
- Return and secure all electrical and service access panels in their proper place.
- Clear surrounding area of all tools, equipment and debris.
- Check the entire unit to ensure its cleanliness.



WARNING



Electrically ground the unit by connecting ground wire to ground lug. Failure to properly ground the unit may result in personal injury or death.



CAUTION



Wire any field installed device such as a fan switch or thermostat furnished by the factory in strict accordance with the wiring diagram supplied with the unit. Failure to properly wire the unit could result in damage to components and will void all warranties.

PRIOR TO THE STARTUP OF THE UNIT

1. Ensure supply voltage matches nameplate data.
2. Ensure the unit is properly grounded
3. With the power off, check blower wheel set screws for proper tightness and that the blower wheel rotates freely.
4. Ensure unit will be accessible for servicing.
5. Ensure condensate line is properly sized, run, trapped, pitched and tested.
6. Ensure all cabinet openings and wiring connections have been sealed.
7. Ensure clean filters are in place.
8. Ensure all access panels are in place and secured.
9. Ensure that all air has been vented from the water coil.
10. Verify that all electrical connections are tight and secure.
11. Check the electrical overcurrent protection and wiring for the correct size.
12. Verify that the low voltage wiring between the thermostat and the unit matches the wiring diagram.

COOL- PAK AC UNITS

1. Set thermostat system switch to “OFF” position and fan switch to “Auto” position. Apply power to the COOL-PAK Unit.
2. Set fan switch to “On”, indoor blower should operate.
3. Return fan switch to “Auto”, indoor blower should de-energize.
4. Set system switch to “Cool” and lower the thermostat set point to coldest setting. The compressor should energize as well as the outdoor fan and indoor blower.
5. Return thermostat set-point to a temperature warmer than room temperature and the compressor, indoor and outdoor fan should de-energize.



NOTE



The COOL-PAK employs a compressor short cycle delay (approx. 3 minutes) which will not allow the compressor to immediately restart following shut down. Additional delays may be experienced if using an electronic digital thermostat.

6. Move system switch to “Heat: and raise thermostat to a set point slightly higher than room temperature (less than 2 degrees). The indoor fan and electric heat should energize.

STARTUP & PERFORMANCE CHECKLIST INSTRUCTIONS:

The warranty may be void unless the **FIGURE 23 – Startup & Performance Checklist** is completed and returned to the warrantor. If the unit is not installed properly, the warranty will be void, as the manufacturer will not be held accountable for problems that stem from improper installation.

TROUBLESHOOTING

PROBLEM	POSSIBLE CAUSE	CHECKS & CORRECTIONS
ENTIRE UNIT DOES NOT RUN	Power supply off	Apply power; close disconnect.
	Blown Fuse	Replace fuse or reset circuit breaker. Check for correct fuses.
	Voltage supply low	If voltage is below minimum voltage specified on unit data plate, contact lower power company.
	Thermostat	Set the fan to "ON", the fan should run. Set thermostat to "COOL" and lowest temperature setting, the unit should run in the cooling mode. Set unit to "HEAT" and the highest temperature setting, the unit should run in the heating mode. If neither the blower nor compressor run in all three cases, the thermostat could be mis-wired or faulty. To ensure mis-wired or faulty thermostat verify 24 volts is available on the condenser section low voltage terminal strip between "R" and "C", "Y" and "C", and "B" and "C". If blower does not operate, verify 24 volts between terminals "G" and "C" in the air handler. Replace the thermostat if defective.
BLOWER OPERATES BUT COMPRESSOR DOES NOT RUN	Thermostat	Check setting, calibration and wiring.
	Wiring	Check for loose or broken wires at compressor, capacitor or contractor.
	Compressor overload open	If the compressor is cool and the overload will not reset, replace the compressor.
	Compressor motor grounded	Internal wiring grounded to the compressor shell. Replace compressor. If compressor burnout, install new filter dryer.
	Compressor windings open	After compressor has cooled, check continually of compressor windings. If the windings are open, replace the compressor.
Refrigerant Sensor	For units over 4lbs, an active refrigerant leak or faulty sensor will disable the compressor operation. Verify absence of refrigerant leak and replace sensor.	
UNIT OFF ON HIGH PRESSURE CONTROL	Discharge pressure too high	In "COOLING" mode: Lack of or inadequate air flow. Entering air temperature too warm. Blower inoperative, clogged filter or restriction in ductwork. In "HEATING" mode: Lack of or inadequate airflow. Entering air temperature too cold. Blower inoperative, clogged filter or restriction in ductwork.
	Refrigerant charge	The unit is overcharged with refrigerant. Reclaim refrigerant, evacuate and recharge with factory recommended charge.
	High pressure switch	Check for defective or improperly calibrated high-pressure switch.
UNIT OFF ON LOW PRESSURE CONTROL	Suction Pressure too low	In "COOLING" mode: Lack of or inadequate air flow. Entering air temperature too cold. Blower inoperative, clogged filter or restriction in ductwork. In "HEATING" mode: Lack of or inadequate airflow. Entering air temperature too warm. Blower inoperative, clogged filter or restriction in ductwork.
	Refrigerant charge	The unit is low on refrigerant. Check for refrigerant leak, repair, evacuate and recharge with factor recommended charge.
	Low pressure switch	Check for defective or improperly calibrated low-pressure switch.
UNIT SHORT CYCLES	Unit oversized	Recalculate heating and cooling loads.
	Thermostat	Thermostat installed near a supply air register, relocate thermostat. Check heat anticipator.
	Wiring and controls	Loose connections in the wiring or a defective compressor contactor.

Table 11 - Troubleshooting Table (1 of 2)

TROUBLESHOOTING (continued)

PROBLEM	POSSIBLE CAUSE	CHECKS & CORRECTIONS
INSUFFICIENT COOLING OR HEATING	Unit undersized	Recalculate heating and cooling loads. If not excessive, possibly adding insulation will rectify the situation.
	Loss of conditioned air by leaks	Check for leaks in ductwork or introduction of ambient air through doors or windows.
	Airflow	Lack of adequate airflow or improper distribution of air. Replace dirty air filter.
	Refrigerant charge	Low on refrigerant charge causing inefficient operation.
	Compressor	Check for defective compressor. If discharge is too low and suction pressure is too high, compressor is not pumping properly. Replace compressor.
	Operating pressures	Compare unit operating pressures to the pressure / temperature chart for the unit.
	Refrigerant metering device	Check for possible restriction or defect. Replace if necessary.
	Moisture, non-condensable	The refrigerant system may be contaminated with moisture or non-condensable. Reclaim refrigerant, evacuate and recharge with factory recommended charge.
A2L SENSOR STATUS LIGHT	SOLID GREEN	Sensor is in startup mode
	BLINKING GREEN	Sensor is in normal operation
	SOLID RED	Sensor has detected a leak and is in mitigation mode
	BLINKING RED	Sensor fault, unit compressor will not energize and fan will be continuous

Table 12 - Troubleshooting Table (2 of 2)

OPERATION & MAINTENANCE

REFRIGERANT CHARGE

Cool-Pak units are factory charged with refrigerant. All units use an adjustable thermostatic expansion valve (TXV) to control refrigerant flow to the evaporator coil. Do not adjust the TXV unless an evaluation of the system as described below indicates it is necessary. Superheat is increased (decrease refrigerant flow) by turning the TXV stem clockwise, turning the stem counter-clockwise will decrease superheat (increase refrigerant flow). Ideal conditions for checking refrigerant charge in cooling mode exist when the outdoor temperature is above 70°F (21° C) and indoor temperature is between 70°F (21°C) & 80°F (26.7° C).

PARTIAL REFRIGERANT CHARGE

Total refrigerant charge is listed on the unit rating plate. For partial system charging, the subcooling and superheat method can be used to make small refrigerant charge adjustments. Optionally, the entire refrigerant charge can be recovered and weighed back in per the total system charge listed on the rating plate. To check the refrigerant charge, actual subcooling & superheat must be determined.

Allow the unit to operate in cooling mode for 15 minutes before taking readings. Attach refrigerant gauges to the suction line and liquid line access ports.

Subcooling

1. Place an accurate temperature sensor on the liquid line as close as practical to the TXV inlet. Insulate the temperature sensor from ambient to assure an accurate line temperature reading.
2. Record the liquid line temperature
3. Record the saturated temperature on your liquid line gauge that corresponds to the pressure shown on your gauge.

Actual Subcooling = saturated liquid line temperature - liquid line temperature

Superheat

- 1) Place an accurate temperature sensor on the suction line as close as practical to the compressor. Insulate the temperature sensor from ambient to assure an accurate line temperature reading
- 2) Record the suction line temperature
- 3) Record the saturated temperature on your suction line gauge that corresponds to the pressure shown on your gauge

Actual superheat = suction line temperature - saturated suction temperature

Compare your actual subcooling and superheat to the target subcooling and superheat.

If subcooling and superheat are both low, adjust the TXV stem clockwise 1/4" turn. Allow the system to stabilize before re-checking.

If subcooling is low and superheat is high, add a small amount of refrigerant. Allow the system to stabilize before re-checking.

If subcooling and superheat are both high, adjust the TXV stem counter-clockwise 1/4" turn. Allow the system to stabilize before re-checking.

If subcooling is high and superheat is low, adjust the TXV stem 1/4" turn clockwise. Recover a small amount of refrigerant. Allow the system to stabilize before re-checking.

COOLING CAPACITY				
Cooling Capacity	12K	18K	24K	30K
Subcooling	8	8	16	10
Superheat at coil	14	7	9	8
Superheat at compressor	17	20	16	10

Table 13



NOTE



Subcooling and superheat readings are reliable when the conditioned space is at comfortable conditions.

OPERATION & MAINTENANCE (continued)

WARNING

FIRE OR EXPLOSION HAZARD

Explosion risk, recover refrigerant only in a cylinder designed and intended for this purpose

- Do not use a damaged cylinder
- Do not apply flame or excessive heat to a refrigerant cylinder
- Do not fill a refrigerant cylinder to more than 80% of its capacity
- Do not use a refrigerant cylinder for anything other than its designed and intended purpose
- Do not use an expired refrigerant cylinder
- Use recovery equipment designed to handle the refrigerant being recovered
- Earth-ground refrigerant cylinders before using

WARNING

Failure to follow this warning could result in personal injury or death. Recover all refrigerant before attempting a sealed air conditioning system repair. Recover all refrigerant before final unit disposal. Use all service ports and position all refrigerant flow-control devices open, including expansion valves and solenoid valves.

CAUTION

Wear all appropriate personal protection equipment when servicing or maintaining this unit. Personal injury can result from sharp metal edges, moving parts, and hot or cold surfaces.

IMPORTANT

It is illegal to discharge refrigerant into the atmosphere. Use proper reclaiming methods and equipment when installing or servicing this unit. Service should be performed by a QUALIFIED service agency. A sealed refrigerant system normally requires no maintenance since it is a closed, self-contained system.

WARNING

FIRE OR EXPLOSION HAZARD

Failure to following this warning could result in personal injury, death and/or property damage.

Do not use flames or any potential ignition sources to leak check R-545B refrigerant tubing or components.

WARNING

ELECTRIC SHOCK HAZARD

HIGH VOLTAGE!

Disconnect all power before servicing. Failure to do so may result in property damage, personal injury, or death.

CAUTION

Compressors and sealed system tubing components may be extremely hot!

CAUTION

Do not use compressors to evacuate the air conditioning system. A vacuum may cause internal electrical arcing resulting in a damaged or failed compressor.

WARNING

Do not exceed the maximum operating pressure listed on the unit rating plate.

WARNING

FIRE OR EXPLOSION HAZARD

ELECTRIC SHOCK HAZARD

Failure to follow safety warnings exactly could result in property damage, dangerous operation, serious injury, or death. Improper servicing could result in dangerous operation, serious injury, death, or property damage.

- Before servicing, disconnect all electrical power to the unit.
 - When servicing controls, label all wires prior to disconnecting. Reconnect wires correctly. Verify proper operation after servicing.

OPERATION & MAINTENANCE (continued)

PREVENTIVE MAINTENANCE

To ensure maximum performance and service life of equipment, a formal schedule of regular preventative maintenance must be established and adhered to.

Failure to do establish and perform preventative maintenance program can void the manufactures warranty.

If servicing or major repairs are required, the complete unit can be removed as follows:

1. Disconnect the electrical power circuit supplying the unit.
2. Remove line and low voltage wiring from unit,
3. Remove rear access panel.
4. Remove supply duct from top of unit.
5. Slide unit back out of sleeve.
6. Unit may be removed from closet.

To reinstall unit, use the installation procedure outlined above.

WARNING

It is a violation of federal law to discharge refrigerant into the atmosphere. Use proper reclaiming methods and equipment when installing or servicing this unit. Service should be performed by a **QUALIFIED** service agency.

The refrigerant system contained in the unit normally requires no maintenance since it is a closed, self-contained system.

CAUTION

All appropriate personal protection equipment should be worn when servicing or maintaining this unit.

Personal injury can result from contact with sharp metal edges, moving parts, and hot or cold surfaces.

FAN

The fan should be inspected and cleaned annually in conjunction with maintenance of the motor and bearings. It is important to keep the fan section and motor clean and free from obstruction to prevent imbalance, vibration, and improper operation.

WARNING

ELECTRIC SHOCK HAZARD

Check motor connections to ensure they are secure and in accordance with the unit wiring diagram.

ECM motors have line voltage power applied at all times.
VERIFY THAT POWER IS DISCONNECTED BEFORE SERVICING.

The air filter should be cleaned or replaced every 30 days or more frequently if severe operating conditions exist. Always replace the filter with the same type and size as originally furnished.

COIL

Clean all heat transfer surfaces and remove all dirt, dust, and contaminants that potentially impairs air flow using industry accepted practices. Care should be taken not to bend coil fin material.

CONDENSATE DRAIN PAN AND PIPE

Check and clean all dirt and debris from pan. Ensure drain line is free flowing and unobstructed.

MAINTENANCE UPDATES

Check regularly for a current copy of the maintenance program log which can be found at under "product information".

UNIT PERFORMANCE

Record performance measurements of volts, amps and air temperature differences (both heating and cooling). A comparison of logged data with start-up and other annual data is useful as an indicator of general equipment condition.

UNIT LOCKOUT

Air flow problems could cause periodic lockouts. The lockout (shutdown) of the units is a normal protective result. Check for airflow rates (may be caused by dirty filter) and air temperatures.

LABORATORY TESTING

When the unit has less than 100 operational hours and the coils have not had sufficient time to be "seasoned", it is necessary to clean the coils with mild surfactant such as calgon to remove the oils left by manufacturing processes.

OPERATION & MAINTENANCE (continued)

Compressor bearing products designed for A2L refrigerants may come equipped with a factory installed refrigerant leak detection system. If the sensor is faulty, or disconnected, the appliance will not properly function.

False ceilings or drop ceilings may be used as a return air plenum if a refrigerant detection system is provided in the appliance and any external connections are also provided with a sensor immediately below the return air plenum duct joint.

QUALIFICATION OF WORKERS

Service shall only be performed by qualified technicians, certified by national training organizations or manufacturers that are accredited to teach the relevant national competency standards that may be set in legislation. Competence to properly service the appliance should be documented by a certificate.

CHECKS TO THE WORK AREA

Prior to beginning work on the appliance, safety checks are necessary to ensure that the risk of ignition of released gasses is minimized. Work shall be undertaken under a controlled procedure so as to minimize the risk of a flammable gas or vapor being present while the work is being performed.

All maintenance staff and others working in the local area shall be instructed on the nature of work being carried out. Work in confined spaces shall be avoided.

CHECKING FOR PRESENCE OF REFRIGERANT

The area shall be checked with an appropriate refrigerant detector prior to and during work, to ensure the technician is aware of potentially toxic or flammable atmospheres. Ensure that the leak detection equipment being used is suitable for use with all applicable refrigerants, i.e. non-sparking, adequately sealed or intrinsically safe.

If any hot work is to be conducted on the refrigerating equipment or any associated parts, appropriate fire extinguishing equipment shall be available to hand. Have a dry powder or CO2 fire extinguisher adjacent to the charging area.

No person carrying out work in relation to a REFRIGERATING SYSTEM which involves exposing any such a pipe work shall use any sources of ignition in manner that it may lead to the risk of fire or explosion.

All possible ignition sources, including cigarette smoking, should be kept sufficiently far away from the site of installation, repairing, removing and disposal, during which refrigerant can possibly be released to the surrounding space. Prior to work taking place, the area around the equipment is to be surveyed to make sure that there are no flammable hazards or ignition risks. "NO SMOKING" signs shall be displayed.

VENTILATED AREA

Ensure that the area is in the open or that it is adequately ventilated before breaking into the system or conducting any hot work. A degree of ventilation shall continue during the period that the work is carried out. The ventilation should safely disperse any released refrigerant and preferably expel it externally into the atmosphere.

CHECKS TO THE REFREIGERATING EQUIPMENT

Where electrical components are being changed, they shall be fit for the purpose and to the correct specification. At all times the manufacturer's maintenance and service guidelines shall be followed. If in doubt, consult the manufacturer's technical department for assistance.

The following checks shall be applied to installations using FLAMMANLE REFRIGERANTS:

- The actual REFRIGERANT CHARGE is in accordance with the room size within which the refrigerant containing parts are installed;
- The ventilation machinery and outlets are operating adequately and are not obstructed;
- Marking to the equipment continues to be visible and legible. Markings and signs that are illegible shall be corrected;
- Refrigerating pipe or components are installed in a position where they are unlikely to be exposed to any substance which may corrode refrigerant containing components, unless the components are constructed of materials which are inherently resistant to being corroded or are suitably protected against being so corroded.

OPERATION & MAINTENANCE (continued)

CHECKS TO ELECTRICAL DEVICES AND SEALED

ELECTRICAL COMPONENTS

Repair and maintenance to electrical components shall include initial safety checks and component inspection procedures. If a fault exists that could compromise safety, then no electrical supply shall be connected to the circuit until it is satisfactorily dealt with. If the fault cannot be corrected immediately but it is necessary to continue operation, an adequate temporary solution shall be used. This shall be reported to the owner of the equipment so all parties are advised.

Initial Safety Checks shall include:

- That capacitors are discharged: this shall be done in a safe manner to avoid possibility of sparking;
- That no live electrical components and wiring are exposed while charging, recovering or purging the system;
- That there is continuity of earth bonding.

Sealed electrical components shall be replaced in the event of damage or malfunction.

CABLING

Check that cabling will not be subject to wear, corrosion, excessive pressure, vibration, sharp edges or any other adverse environmental effects. The check shall also take into account the effects of aging or continual vibration from sources such as compressors or fans.

DETECTION OF FLAMMABLE REFRIGERANTS

Under no circumstances shall potential sources of ignition be used in the searching for or detection of refrigerant leaks. A halide torch (or any other detector using a naked flame) shall not be used.

Electronic leak detectors may be used to detect refrigerant leaks but, in the case of FLAMMABLE REFRIGERANTS, the sensitivity may not be adequate, or may need re-calibration. (Detection equipment shall be calibrated in a refrigerant-free area.) Ensure that the detector is not a potential source of ignition and is suitable for the refrigerant used. Leak detection equipment shall be set at a percentage of the LFL of the refrigerant and shall be calibrated to the refrigerant employed, and the appropriate percentage of gas (25 % maximum) is confirmed.

Leak detection fluids (such as the bubble method or fluorescent method agents) are also suitable for use with most refrigerants but the use of detergents containing

chlorine shall be avoided as the chlorine may react with the refrigerant and corrode the copper pipe-work.

If a leak is suspected, all naked flames shall be removed/extinguished. If a leakage of refrigerant is found which requires brazing, all of the refrigerant shall be recovered from the system, or isolated (by means of shut off valves) in a part of the system remote from the leak.

REMOVAL AND EVACUATION OF FLAMMABLE REFRIGERANTS

When breaking into the refrigerant circuit to make repairs – or for any other purpose – conventional procedures shall be used. However, for FLAMMABLE REFRIGERANTS it is important that best practice is followed since flammability is a consideration. The following procedure shall be adhered to:

- Remove refrigerant charge following local and national regulations
- Purge the circuit with inert gas (optional for A2L);
- Evacuate (optional for A2L)
- If using flame to open circuit, continuously flush system with an inert gas
- Open the circuit by cutting or brazing.

The refrigerant charge shall be recovered into the correct recovery cylinders if venting is not allowed by local and national codes. For appliances containing flammable refrigerants, the system shall be purged with oxygen-free nitrogen to render the appliance safe for flammable refrigerants. This process might need to be repeated several times. Compressed air or oxygen shall not be used for purging refrigerant systems.

For appliances containing flammable refrigerants, refrigerant purging shall be achieved by breaking the vacuum in the system with oxygen-free nitrogen and continuing until the working pressure is achieved, then venting to the atmosphere, and finally pulling down to a vacuum (optional for A2L). This process shall be repeated until no refrigerant is within the system (optional for A2L). When the final oxygen-free nitrogen charge is used, the system shall be vented down to atmospheric pressure to enable work to take place. The outlet for the vacuum pump shall not be close to any potential ignition sources, and ventilation shall be available.

OPERATION & MAINTENANCE (continued)

CHARGING PROCEDURES

In addition to conventional charging procedures, the following requirements shall be followed.

- Ensure that contamination of different refrigerants does not occur when using charging equipment. Hoses or lines shall be as short as possible to minimize the amount of refrigerant contained in them.
- Cylinders shall be kept in an appropriate position according to the instructions.
- Ensure that the REFRIGERATING SYSTEM is earthed prior to charging the system with refrigerant.
- Label the system when charging is complete (if not already).
- Extreme care shall be taken not to overfill the REFRIGERATING SYSTEM.

Prior to recharging the system, it shall be pressure-tested with the appropriate purging gas. The system shall be leak-tested on completion of charging but prior to commissioning. A follow up leak test shall be carried out prior to leaving the site.

DECOMMISSIONING

Before carrying out this procedure, it is essential that the technician is completely familiar with the equipment and all its detail. It is recommended good practice that all refrigerants are recovered safely. Prior to the task being carried out, an oil and refrigerant sample shall be taken in case analysis is required prior to re-use of recovered refrigerant. It is essential that electrical power is available before the task is commenced.

- A. Become familiar with the equipment and its operation.
- B. Isolate system electrically.
- C. Before attempting the procedure, ensure that:
 - a. mechanical handling equipment is available, if required, for handling refrigerant cylinders;
 - b. all personal protective equipment is available and being used correctly;
 - c. the recovery process is supervised at all times by a competent person;
 - d. recovery equipment and cylinders conform to the appropriate standards.
- D. Pump down refrigerant system, if possible.
- E. If a vacuum is not possible, make a manifold so that refrigerant can be removed from various parts of the system.

- F. Make sure that cylinder is situated on the scales before recovery takes place.
- G. Start the recovery machine and operate in accordance with instructions.
- H. Do not overfill cylinders (no more than 80 % volume liquid charge).
- I. Do not exceed the maximum working pressure of the cylinder, even temporarily.
- J. When the cylinders have been filled correctly and the process completed, make sure that the cylinders and the equipment are removed from site promptly and all isolation valves on the equipment are closed off.
- K. Recovered refrigerant shall not be charged into another REFRIGERATING SYSTEM unless it has been cleaned and checked.

LABELING

Equipment shall be labelled stating that it has been de-commissioned and emptied of refrigerant. The label shall be dated and signed. For appliances containing FLAMMABLE REFRIGERANTS, ensure that there are labels on the equipment stating that the equipment contains FLAMMABLE REFRIGERANT.

RECOVERY

When removing refrigerant from a system, either for servicing or de-commissioning, it is recommended good practice that all refrigerants are removed safely. When transferring refrigerant into cylinders, ensure that only appropriate refrigerant recovery cylinders are employed. Ensure that the correct number of cylinders for holding the total system charge is available. All cylinders to be used are designated for the recovered refrigerant and labelled for that refrigerant (i.e. special cylinders for the recovery of refrigerant). Cylinders shall be complete with pressure-relief valve and associated shut-off valves in good working order. Empty recovery cylinders are evacuated and, if possible, cooled before recovery occurs.

The recovery equipment shall be in good working order with a set of instructions concerning the equipment that is at hand and shall be suitable for the recovery of the flammable refrigerant. If in doubt, the manufacturer should be consulted. In addition, a set of calibrated weighing scales shall be available and in good working order. Hoses shall be complete with leak-free disconnect couplings and in good condition.

OPERATION & MAINTENANCE (continued)

The recovered refrigerant shall be processed according to local Legislation in the correct recovery cylinder, and the relevant waste transfer note arranged. Do not mix refrigerants in recovery units and especially not in cylinders.

If compressors or compressor oils are to be removed, ensure that they have been evacuated to an acceptable level to make certain that flammable refrigerant does not remain within the lubricant. The compressor body shall not be heated by an open flame or other ignition sources to accelerate this process. When oil is drained from a system, it shall be carried out safely

REFRIGERANT DETECTION SENSOR (RDS) INFORMATION

Refer to the appliance IOM for information regarding the minimum conditioned room requirements, and instructions for the RDS operation, installation, and wiring. Any field installed wiring connected to the RDS must be at least 18AWG and have minimum insulation thickness of 1.58mm or be protected from damage.

The RDS is not intended for service or repair. In the event of a sensor failure, the mitigation mode will engage and the sensor shall be replaced by removing the sensor and replacing it with a new sensor.

DUCTING

If the appliance is connected via an air duct system to one or more rooms with A2L refrigerants is installed in a room with an area of less than the minimum as noted on the unit physical data table, or a minimum effective dispersal volume less than 18m³(636 ft³), the room shall be without continuously operating open flames (e.g. an operating gas appliance), or other potential ignition sources (such as an operating electric heater/ hot surface). A flame producing device may be installed in the same space if the device is provided with an effective flame arrest.

Auxiliary devices which may be a potential ignition source shall not be installed in the duct work. Potential ignition sources include hot surfaces with a temperature exceeding 430°C (806°F) and electric switching devices.

PIPING

Pipe-work including piping material, pipe routing, and installation shall include protection from physical damage in operation and service, and be in compliance with national and local codes and standards, such as AHRAE 15, ASHRAE 15.2, IAPMO uniform mechanical code, ICC International Mechanical Code, or CSA B52. All field joints shall be accessible for inspection prior to being covered or enclosed.

STARTUP & PERFORMANCE CHECKLIST



CUSTOMER _____ STARTUP DATE _____ JOB # _____
 ADDRESS _____ SERVICING COMPANY _____
 _____ TECHNICIAN _____
 MODEL # _____ SERIAL # _____ PHONE # _____

INSTALLATION CHECK LIST

- Inspect the unit for transit damage and report any damage on the carrier's freight bill.
- Check model number to insure it matches the job requirements.
- Install field accessories and unit adapter panels as required. Follow accessory and installation manuals.
- Verify field wiring, including the wiring to any accessories.
- Check all multi-tap transformers, to ensure they are set to the proper incoming voltage.
- Power the unit. Bump the motor contractor to check rotation. Three phase motors are synchronized at the factory. If the blower fans are running backwards, de-energize power to the unit, then swap two of the three incoming electrical lines to obtain proper phasing. Re-check.
- Perform all start up procedures outline in the installation manual shipped with the unit.
- Fill in the Start Up information as outlined below and on the following page.
- Provide owner with information packet. Explain the thermostat and unit operation.

START UP INFORMATION SHEET

ELECTRICAL

Supply Voltage L1-L2 _____ Compressor Amps _____
 Running Voltage L1-L2 _____ Blower Amps _____
 Secondary Voltage _____ Condenser Fan Amps _____
 C (black) to G (green) Volts* _____
 C (black) t W (white) Volts* _____

AIRFLOW

Intake Design CFM	Exhaust Design CFM
Pressure Drop _____	Pressure Drop _____
Calculated CFM _____	Calculated CFM _____
Amb db Temp _____	Amb db Temp _____
Return Air db Temp* _____	Return Air db Temp* _____
Tempered Air db Temp* _____	Tempered Air db Temp* _____

TEMPERATURES

Outdoor Air Temperature _____ DB _____ WB	Cooling Supply Air Temperature _____ DB _____ WB
Return Air Temperature _____ DB _____ WB	Heating Supply Air Temperature _____ DB _____ WB

Figure 23 – Startup & Performance Checklist

NOTES



P.O. Box 270969 Dallas, TX 75227
www.firstco.com or www.ae-air.com

The manufacturer works to continually improve its products. It reserves the right to change design and specifications without notice.

©2023 First Co., Applied Environmental Air